

EVERGREEN™ VENTO™ FCM10K

10,000 W Bulk Front End

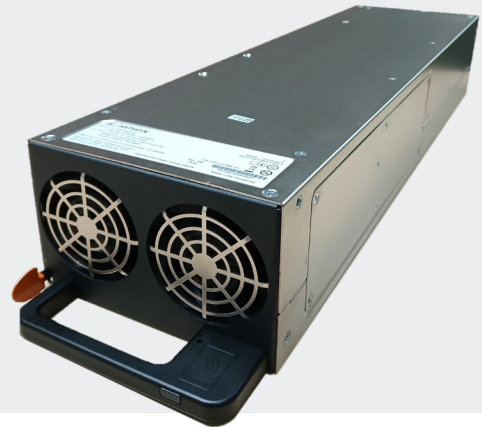

Advanced Energy's FCM10K series provides for three phase three wire of AC-DC embedded power requirements. Featuring high build quality with robust screw terminals, long life, and typical full-load efficiency of greater than 95.5%, these units are ideal for use in industrial applications. They are backed by a comprehensive set of industrial safety approvals and certificates. Variable-speed "smart fans" draw on software controls developed by Advanced Energy to match fan speed to the unit's cooling requirement and load current. Slowing the fan not only saves power but also reduces wear, thus extending its life.

SPECIAL FEATURES

- 10,000 W output power
- 81.6 mm x 125.85 mm x 460 mm
- -40 to +50°C
- 5 V at 2 A housekeeping
- High efficiency: 95.5% typical
- Supports NFC Tag Application
- Semi F47 compliance
- Five-year warranty

COMPLIANCE

- EMI Class B, with 6 db margin
- EN61000 Immunity

SAFETY

- UL/IEC/TUV 62368-1
- CE LVD (EN62368-1 + RoHS)
- CB Report Demko for IEC60950-1

AT A GLANCE

Total Power

10,000 W

Input Voltage

187 to 528 VAC, 3 Phase 3 Wire + PE

Number of Outputs

Single



ELECTRICAL SPECIFICATIONS

Input	
Input Range	187 to 528 VAC 3 phase input 480 VAC (nominal)
Frequency	47 to 63 Hz, nominal 50/60 Hz
Input Fusing	Internal 20 A non-replaceable fuses per line
Inrush Current	≤ 60 A peak at 480 VAC
Power Factor	0.99 typical at nominal input, 50 to 100% of full load, meets EN61000-3-2
Harmonics	Meets IEC 61000-3-2 requirements
Input Current	15 A RMS max input current at 480 VAC
Hold Up Time	12 ms min for at 10,000 W load 20 ms min for at 6000 W load Note: At nominal output voltage
Efficiency	> 95.5% typical at full load, 480 VAC nominal
Leakage Current ³	< 7 mA at 480 VAC, 60 Hz, tested at Delta configuration
Power Line Transient	Suitable MOV after input fuse
Isolation Voltage	Meets UL62368

Output		
Output Voltage	Main output: 54.5 VDC Standby output: 5 VDC	
Output Trimming Range	48 to 60 VDC	
Output Current	Main output at 183.5 A max Standby at 2 A	
Minimum Load	Main output at 0 A Standby at 0 A	
Output Ripple/Noise (PARD)	Main output: 1% of voltage setting Standby: 100 mV max	Measured with 0.1 μF ceramic and 10 μF tantalum capacitor on any output, 20 MHz
Output Voltage Turn-on Overshoot	< 5% of voltage setting	Rise is monotonic
Transient Response	± 5% of nominal output voltage	Load transient change of ±25%
Current Sharing Accuracy	< 5% for 50 to 100% load current	Standby: none
Max Number of Unit in Parallel	6 units	
Protections	UV/OV, OCP, OTP, ACUV, etc.	
Output Isolation	Main output is isolated from PSU chassis and meets functional isolation requirements 100 VDC. Design has suitable provision to connect output return to chassis.	

Output Power Derating vs Input Line Voltage	
480 VAC	10,000 W
440 VAC	10,000 W
400 VAC	9200 W
380 VAC	8700 W
360 VAC	8300W
346 VAC	8000 W
240 VAC	5500 W
208 VAC	4800 W

ELECTRICAL SPECIFICATIONS

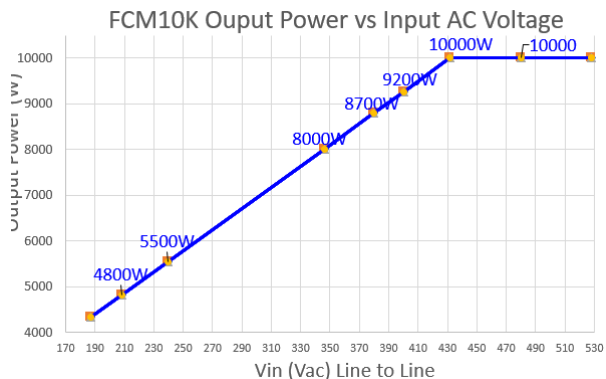

ENVIRONMENTAL SPECIFICATIONS

Operating Temperature	-40 to +50°C; Start at -40°C requires a 5 minute operating warm-up. Above +50 to +70°C, power derated linearly
Storage Temperature	-40 to +85°C
Humidity	10 to 90% non-condensing, operating
Acoustic Noise	< 72 dBA at 30°C
Altitude	3000 m for 100% load 5000 m with derated power (TBD)
Shock	Operating Shock 1: 4 G, 22ms, half-sine pulse Operating Shock 2: 15 G, 11ms, half-sine pulse Non-operating Shock: 30 G, 11ms, half-sine pulse
Vibration	Operating Vibration: IPC-9592B Class 1; Random, 0.71 G rms, 10 to 500Hz Non-operating Vibration: IPC-9592B Class 1, Random, 1.9 Grms, 5 to 500Hz Package: MIL-STD-810G, Method 514.6 Procedure I, Cat 7, Table 514.6C-VII, General Exposure

SAFETY & EMC

Conducted/Radiated Emission	EN55032/CISPR32 Class B, 6 dB Margin
Surge	2 kV DM, 4 kV CM
Voltage Dips and Interruptions	EN61000-4-11 SEMI F47
ESD	8 kV contact/15 kV air
Safety	UL/IEC/TUV 62368-1
Compliance Reports	CE LVD, CB Report Demko for IEC60950-1, TUV SUD, IEC62368, ROHS3

ORDERING INFORMATION

Standard	Nominal Output Voltage	Trim Range	Max Current	Standby Output	Efficiency
FCM10KW-N	54.5 VDC	48 to 60 VDC	183.5 A	5 V at 2 A	95.5%

Note: Add "-T" for Terminal Block

Add "-P" for Pluggable Connector

MECHANICAL DRAWINGS (-P)

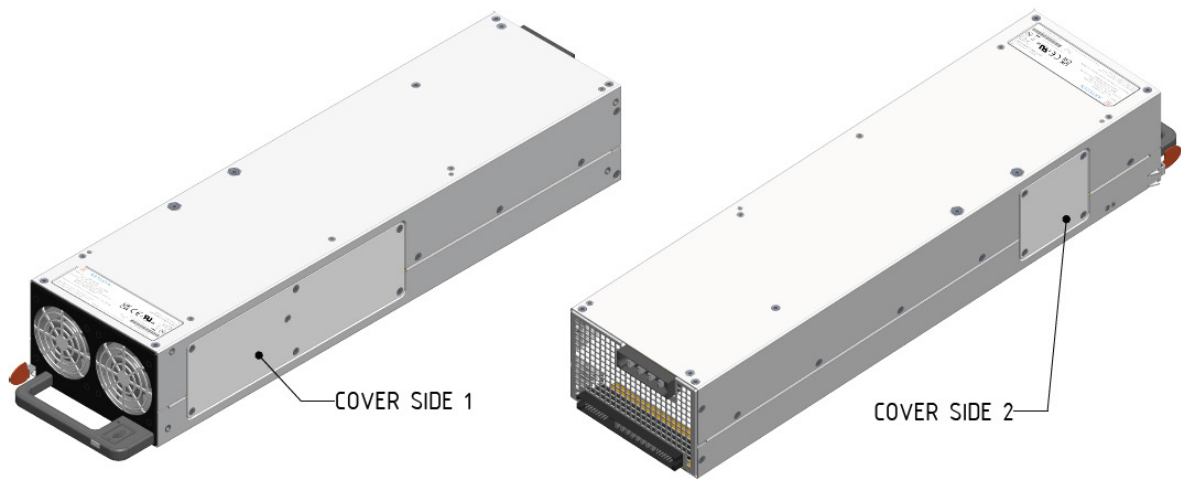
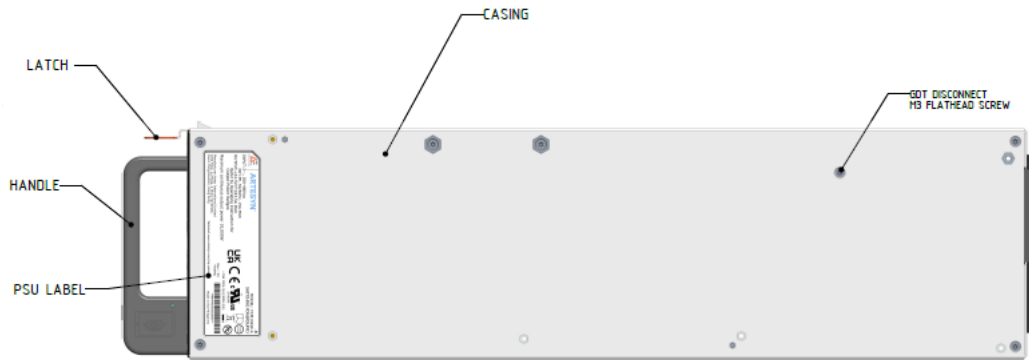

MECHANICAL DRAWINGS (-P)

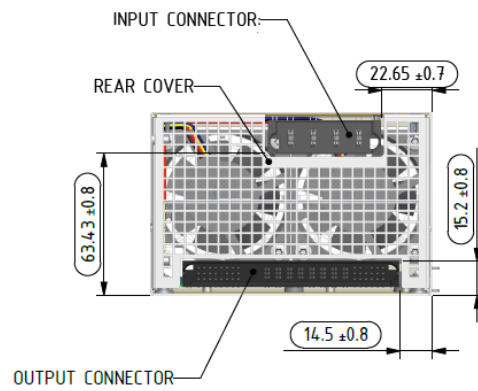
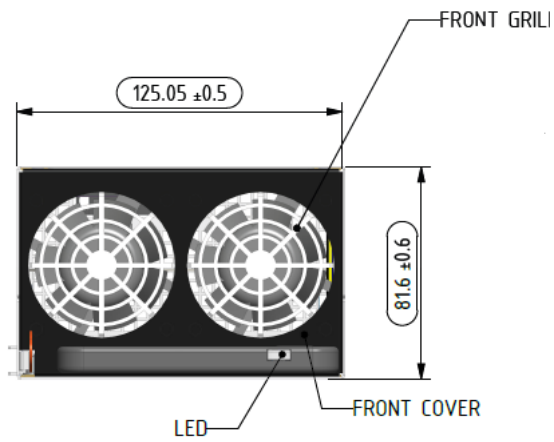
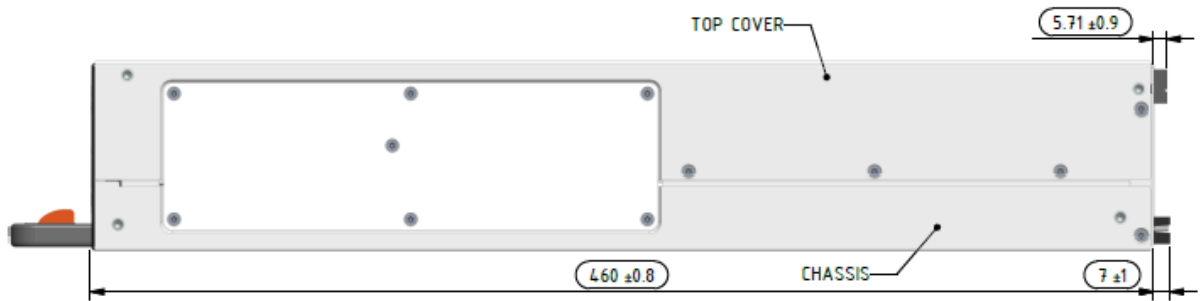

MECHANICAL DRAWINGS (-T)

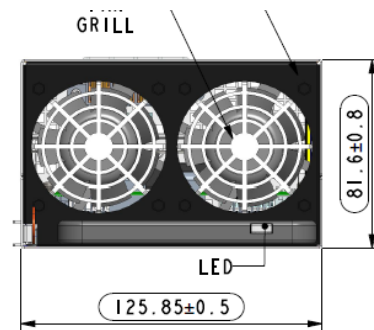
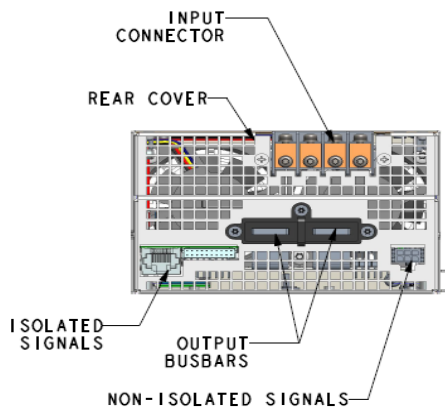
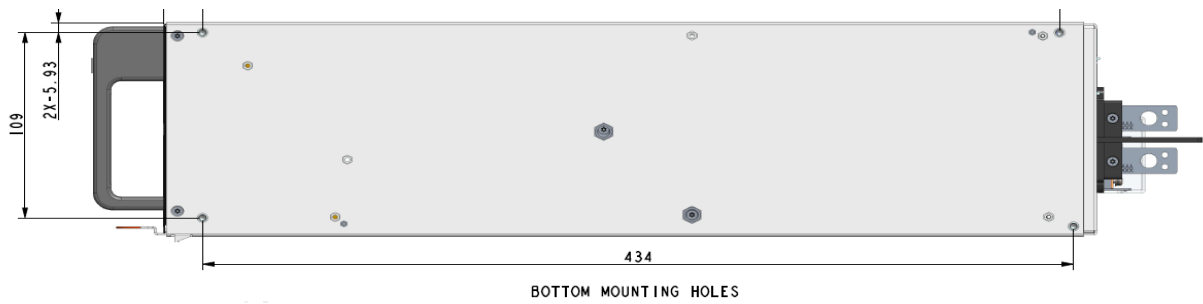
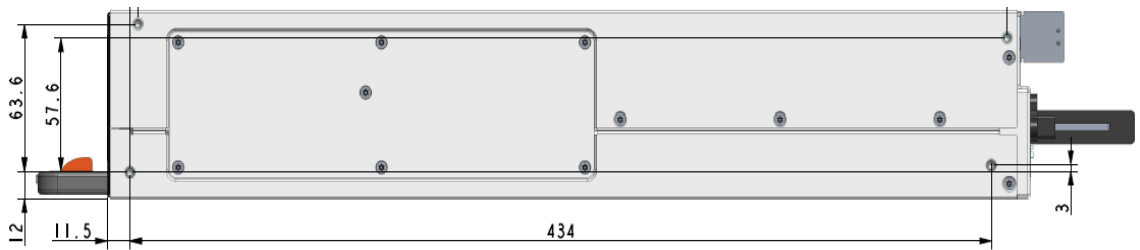

Note: This is draft only for reference

PIN ASSIGNMENT

ISOLATED SIGNALS	PIN #
RS485_A_EXT	C5
RS485_B_EXT	C6
RS485_GND	B6
RS485_ADDR0	A7
RS485_ADDR1	C7
RS485_ADDR2	C8
ACOK#	B1
PWR_OK#	C1
ALERT#	B4
PSON#	C3
V_PROG	B3
I_PROG	C2
CC/CV_MODE	C4
PSU_PRESENT	B8
GNDL	A8
5VSB	A1
5VSB_GND	B2
PSKLL_ISO	B5
ANALOG/DIGITAL_MODE	A3
VPROG/IPROG_GND	A5

NON-ISOLATED SIGNALS	PIN #
PSKLL	C11
ISHARE	C14
ISHARE_RETURN	C9
SYS_GND	C10
PSU_SYNC	C13
SHLF_DET	B12

POWER	PIN #
Main Vout+	P2 - P5
Main Vout Return	P6 - P9

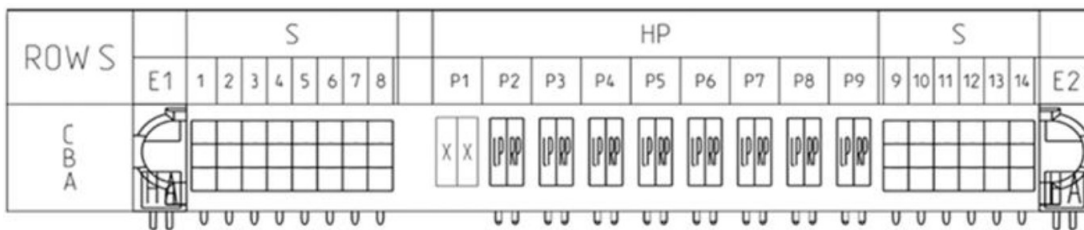
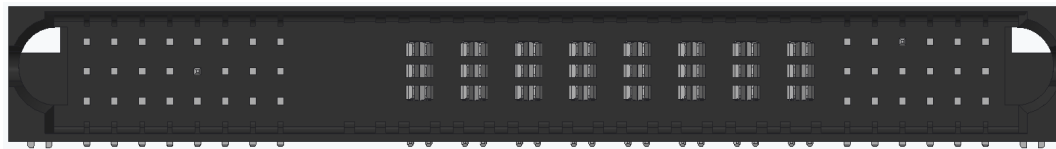

INPUT CONNECTOR

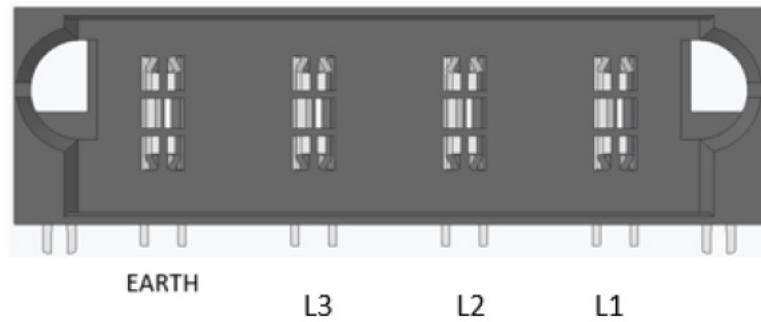

- Three phase AC input using three wire and PE
- Supports star or Delta three phase(no corner grounding)

MISCELLANEOUS SPECIFICATIONS

BURN-IN

100% Burn-in at 45°C, at 80 to 90% load. Duration of burn-in determined by Quality Assurance Procedures.

MTBF

The power supply has a minimum MTBF of 200,000 hours using the Telcordia 2 Method, with specifications at 25°C, ambient, at full load. With the power supply installed in a system in a 35°C ambient environment and operating at full load, capacitor life shall be five (5) years, minimum for ALL electrolytic capacitors contained within this power supply. The power supply shall demonstrate an MTBF level of > 500,000 hours based on actual field population operational hours.

QUALITY ASSURANCE

Full QAV testing shall be conducted in accordance with Advanced Energy standards.

WARRANTY

Advanced Energy shall warrant the power supply to be free of defects in materials and workmanship for a minimum period of five (5) years from the date of shipment, when operated within specifications. The warranty shall be fully transferable to the end owner of the equipment powered by the supply.



For international contact information,
visit [advancedenergy.com](https://www.advancedenergy.com).

powersales@aei.com (Sales Support)
productsupport.ep@aei.com (Technical Support)
+1 888 412 7832

ABOUT ADVANCED ENERGY

Advanced Energy (AE) has devoted more than three decades to perfecting power for its global customers. AE designs and manufactures highly engineered, precision power conversion, measurement and control solutions for mission-critical applications and processes.

Our products enable customer innovation in complex applications for a wide range of industries including semiconductor equipment, industrial, manufacturing, telecommunications, data center computing, and medical. With deep applications know-how and responsive service and support across the globe, we build collaborative partnerships to meet rapid technological developments, propel growth for our customers, and innovate the future of power.

PRECISION | POWER | PERFORMANCE | TRUST

Specifications are subject to change without notice. Not responsible for errors or omissions. ©2024 Advanced Energy Industries, Inc. All rights reserved. Advanced Energy®, AE®, Evergreen™, and Vento™ are U.S. trademarks of Advanced Energy Industries, Inc.