

ARTESYN CSV2000BP SERIES

2000 Watts Distributed Power System

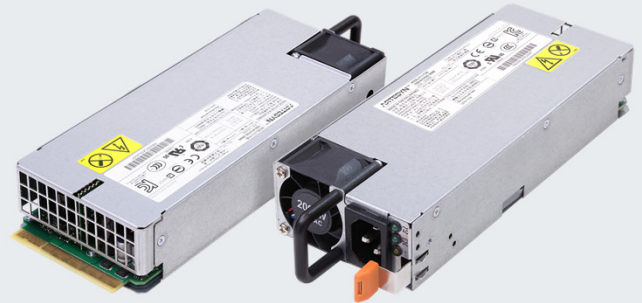

PRODUCT DESCRIPTION

Advanced Energy's Artesyn CSV series bulk front end power AC-DC supply is designed for systems where scalability and density are requirements. With multiple power levels to choose from, this family provides designers with the ability to change the power supply to optimize according to system power consumption.

Note 1 - For UL covered area that allows 11A input current rating.

AT A GLANCE

Total Power:

2000 Watts¹

Input Voltage:

180 to 264 Vac¹

of Outputs:

Main and Standby

SPECIAL FEATURES

- 2000W output power at high line
- 1U power supply
- High power and short form factor
- High density design: 25W/in³
- Active power factor correction
- EN61000-3-2 harmonic compliance
- Inrush current control
- 80 PLUS[®] Platinum efficiency
- N+N redundant
- Hot-pluggable
- Active current sharing
- Inrush current control
- Two-year warranty
- RoHS
- Class A conducted / radiated EMI
- PMBus[™] compliant

SAFETY

- UL/cUL
- CB Report Certificate
- CQC
- CE Mark
- BSMI
- KC
- TUV
- BIS

TYPICAL APPLICATIONS

- Industrial



MODEL NUMBERS

Standard	Output Voltage	Minimum Load ¹	Maximum Load	Stand-By Supply	Air Flow Direction
CSV2000BP-3	12.2Vdc	1A	163.9A	12Vdc@3A	Normal (DC Connector to Handle)

Note 1 - 1A minimum current for transient load response testing only. Unit is designed to operate and be within output regulation range at zero load.

Options

None

ELECTRICAL SPECIFICATIONS

Absolute Maximum Ratings

Stress in excess of those listed in the “Absolute Maximum Ratings” may cause permanent damage to the power supply. These are stress ratings only and functional operation of the unit is not implied at these or any other conditions above those given in the operational sections of this TRN. Exposure to any absolute maximum rated condition for extended periods may adversely affect the power supply’s reliability.

Table 1. Absolute Maximum Ratings						
Parameter	Models	Symbol	Min	Typ	Max	Unit
Input Voltage AC continuous operation	All models	$V_{IN,AC}$	180 ¹	-	264	Vac
		$V_{IN,AC}$	198	-	264	Vac
Maximum Output Power	All models	$P_{O,max}$	-	-	2000	W
Isolation Voltage Input to outputs Input to safety ground	All models		-	-	4243	Vdc
	All models		-	-	3000	Vdc
Ambient Operating Temperature ²	All models	T_A	5	-	50	°C
Storage Temperature	All models	T_{STG}	-40	-	70	°C
Humidity (non-condensing) Operating Non-operating	All models		8	-	93	%
	All models		5	-	100	%
Altitude ² Operating Non-operating	All models		-	-	10000	Feet
	All models		-	-	50000	Feet
MTBF $T_A = 40^{\circ}\text{C}$ $I_O = 70\%I_{O,max}$ Nominal input	All models		-	-	500	KHours
Operating Life	All models		5	-	-	Years

Note 1 - For UL covered area that allows 11A input current rating.

Note 2 - PSU ambient temperature derated at 1°C per 600 feet above 3000 feet.

ELECTRICAL SPECIFICATIONS

Input Specifications

Table 2. Input Specifications						
Parameter	Condition	Symbol	Min	Typ	Max	Unit
Operating Input Voltage, AC	All	$V_{IN,AC}$	180 ¹	200-240	264	Vac
		$V_{IN,AC}$	198	200-240	264	Vac
Input AC Frequency	All	$f_{IN,AC}$	47	50/60	63	Hz
Maximum Input Current ($I_O = I_{O,max}$, $I_{SB} = I_{SB,max}$)	$V_{IN,AC} = 180Vac$ $V_{IN,AC} = 198Vac$	$I_{IN,max}$	-	-	11 ¹	A
			-	-	10	
No Load Input Power ($V_O = On$, $I_O = 0A$, $I_{SB} = 0A$)	All	$P_{IN,no-load}$	-	-	5	W
Harmonic Line Currents	All	THD	Per EN / IEC 61000-3-2			
Power Factor	$I_O > 10\%I_{O,max}$	PF	0.90	-	-	
Startup Surge Current (Inrush) @ 25°C	$V_{IN,AC} = 264Vac$	$I_{IN,surge}$	-	-	30	Apk
Input Fuse	Internal, L 5x20mm, Quick Acting 16A, 420Vdc		-	-	16	A
Leakage Current to Earth Ground	$V_{IN,AC} = 264Vac$ $f_{IN,AC} = 50Hz$		-	-	0.575	mA
Operating Efficiency @ 25°C	$V_{IN,AC} = 230Vac$ $I_O = 10\%I_{O,max}$ $I_O = 20\%I_{O,max}$ $I_O = 50\%I_{O,max}$ $I_O = 100\%I_{O,max}$	η	89	-	-	%
			90	-	-	%
			94	-	-	%
			91	-	-	%
System Stability Phase Margin			45	-	-	°

Note 1 - For UL covered area that allows 11 A input current rating.

ELECTRICAL SPECIFICATIONS

Output Specifications

Table 3. Output Specifications						
Parameter	Condition	Symbol	Min	Typ	Max	Unit
Factory Set Voltage	All	V_O	-0.20%	12.2	0.20%	Vdc
		V_{SB}	-3.5%	12.0	3.5%	Vdc
Output Regulation	Inclusive of set-point, temperature change, warm-up drift and dynamic load	V_O	11.59	12.2	12.81	Vdc
		V_{SB}	11.4	12.0	12.6	Vdc
Output Ripple, pk-pk	Measure with a 0.1 μ F ceramic capacitor in parallel with a 10 μ F tantalum capacitor, 10 to 20MHz bandwidth	V_O	-	-	120	mV _{PK-PK}
		V_{SB}	-	-	120	mV _{PK-PK}
Output Current ¹	All	I_O	1	-	163.9	A
	All	I_{SB}	0.5	-	3	A
Main Output Current Share Accuracy	30% to 50% $I_{O,max}$ 50% to 100% $I_{O,max}$	% I_O	- -	- -	10 6	%
Load Capacitance	Turn-on / Turn-off	C_O	100	-	25000	μ F
		C_{SB}	50	-	500	μ F
Main Output Dynamic Response ² Peak Deviation	80% load change, slew rate = 0.5A/us	V_O	11.59	-	12.81	V

Note 1 - 1A minimum current for transient load response testing only. Unit is designed to operate and be within output regulation range at zero load.

Note 2 - Allowable output voltage variation due to a peak load change starting with a minimum of 1A load, stepping up to 80% of the rated load at a slew rate of 0.5A/us. Minimum output capacitance 2000 μ F.

Load changes from minimum to maximum or maximum to minimum may cause output voltage to go out of regulation but shall not cause the power supply to shut down.

ELECTRICAL SPECIFICATIONS

System Timing Specifications

Table 4. System Timing Specifications					
Label	Parameter	Min	Typ	Max	Unit
T1	Delay from AC being applied to V_{SB} being within regulation.	-	-	2500	mSec
T2	Rise time of output voltage going from 10% to 90% of the nominal regulation.	1	-	50	mSec
T3	Delay from AC being applied to main output being within regulation.	-	-	3000	mSec
T4	Delay from output voltages within regulation limits to DC_GOOD/PWOK assertion.	180	-	220	mSec
T5	Delay from ACOK going low to deassertion of DC_GOOD/PWOK.	6	-	-	mSec
T6	Delay from loss of AC to main output being within regulation.	12	-	-	mSec
T7	Delay from loss of AC to standby output being within regulation.	50	-	1000	mSec
T8	Delay from deassertion of DC_GOOD/PWOK to output falling out of regulation.	2	-	-	mSec
T9	Delay from deassertion of PSON to deassertion of DC_GOOD/PWOK.	-	-	1	mSec
T10	Delay from PSON_L assertion to output being within regulation.	-	-	100	mSec

ELECTRICAL SPECIFICATIONS

System Timing Diagram

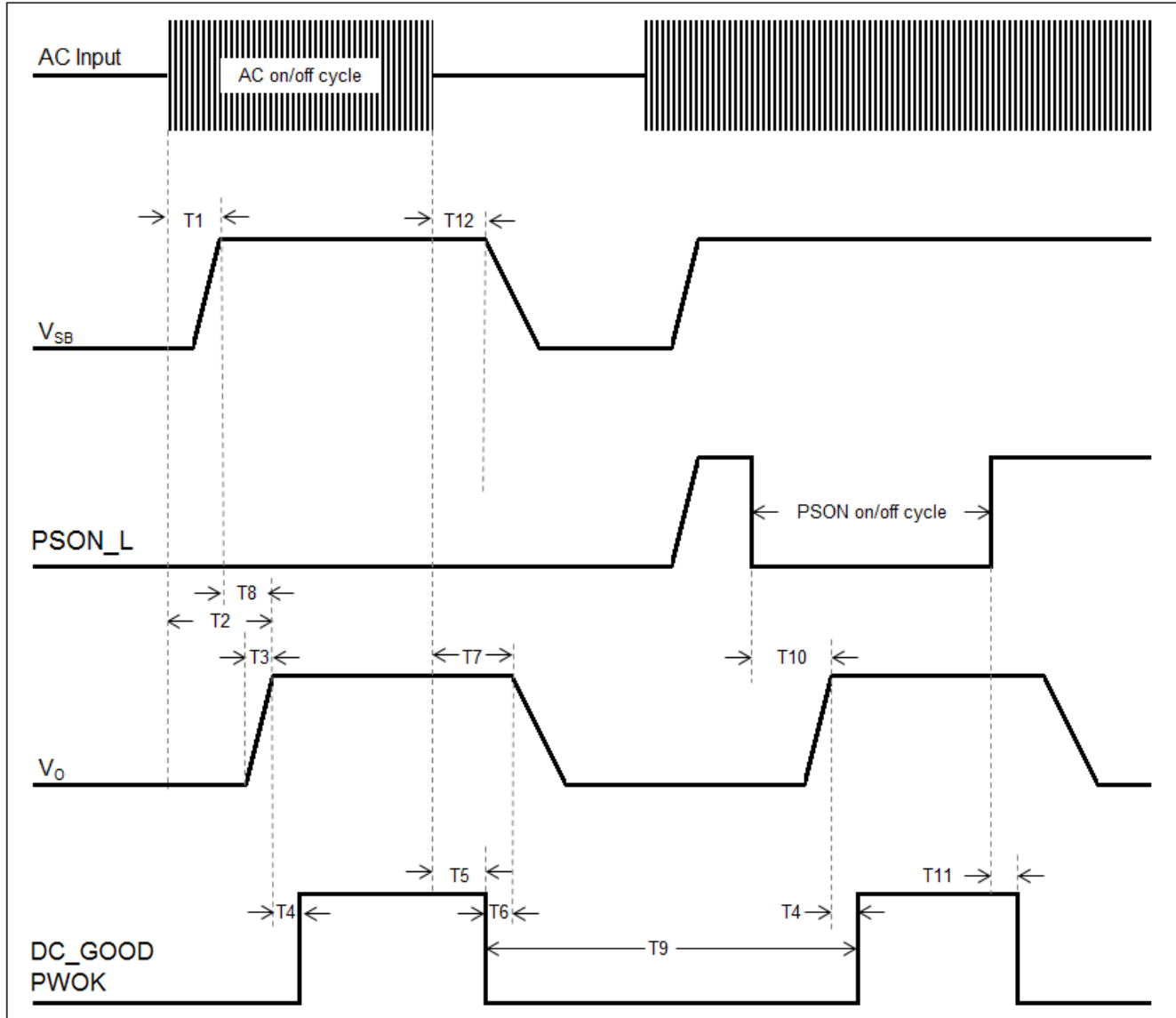

ELECTRICAL SPECIFICATIONS

CSV2000BP-3 Performance Curves

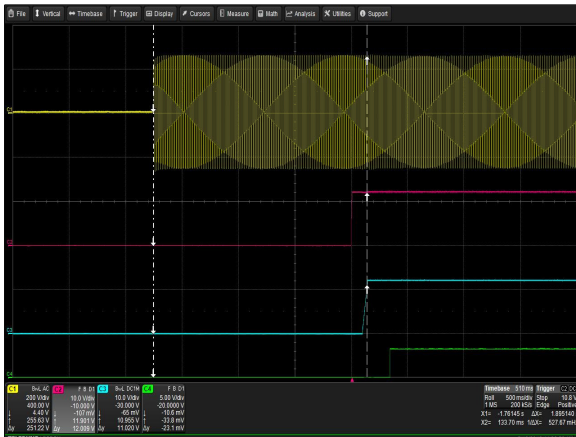

Figure 1: CSV2000BP-3 Turn-On Delay via AC Mains
 Vin = 180Vac Load: $I_O = 163.9A$ $I_{SB} = 3A$
 Ch 1: AC Mains Ch 2: V_{SB} Ch 3: V_O Ch 4: PWOK

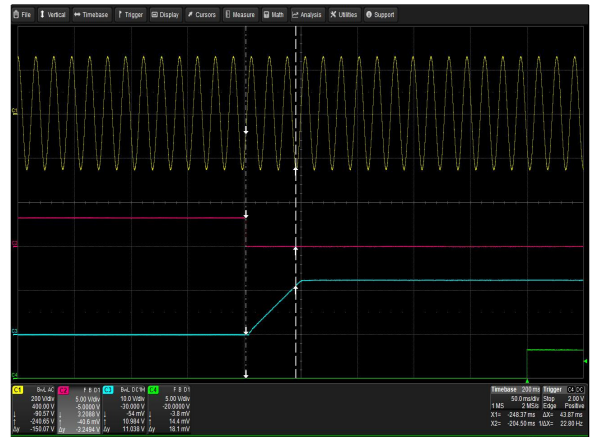

Figure 2: CSV2000BP-3 Turn-On Delay via PSON
 Vin = 180Vac Load: $I_O = 163.9A$ $I_{SB} = 3A$
 Ch 1: AC Mains Ch 2: PSON Ch 3: V_O Ch 4: PWOK

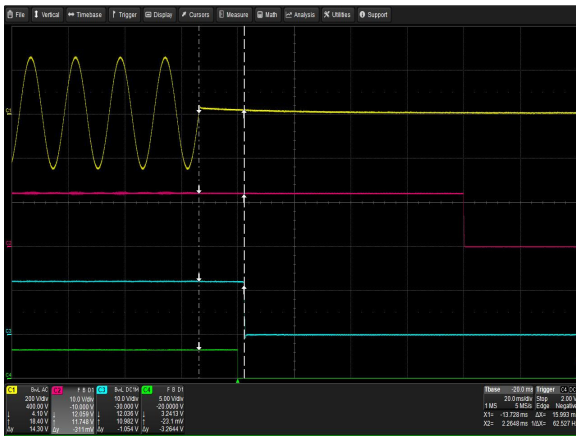

Figure 3: CSV2000BP-3 Hold-up Time
 Vin = 180Vac/0° fin = 63Hz Load: $I_O = 163.9A$ $I_{SB} = 3A$
 Ch 1: AC Mains Ch 2: V_{SB} Ch 3: V_O Ch 4: PWOK

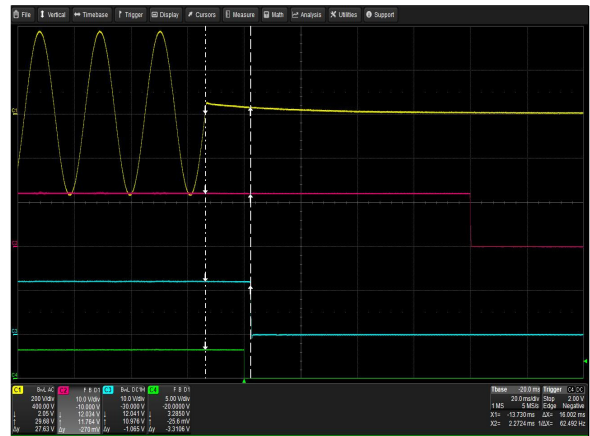

Figure 4: CSV2000BP-3 Hold-up Time
 Vin = 264Vac/0° fin = 47Hz Load: $I_O = 163.9A$ $I_{SB} = 3A$
 Ch 1: AC Mains Ch 2: V_{SB} Ch 3: V_O Ch 4: PWOK

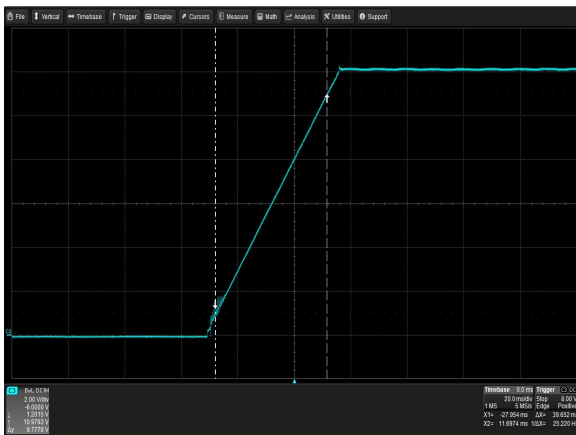

Figure 5: CSV2000BP-3 Output Voltage Startup Characteristic
 Vin = 180Vac Load: $I_O = 163.9A$ $I_{SB} = 3A$
 Ch 3: V_O

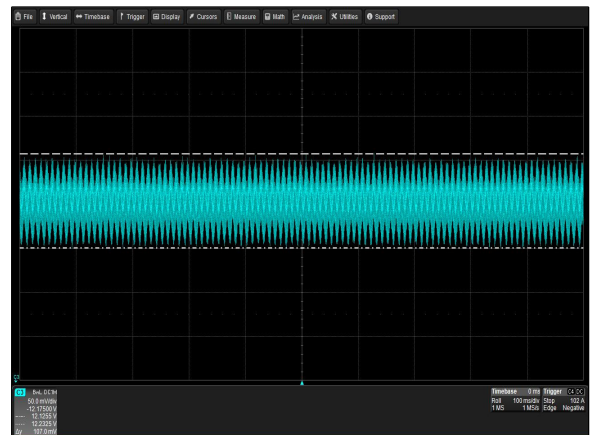

Figure 6: CSV2000BP-3 Ripple and Noise Measurement
 Vin = 180Vac Load: $I_O = 163.9A$ $I_{SB} = 3A$
 Ch 3: V_O

ELECTRICAL SPECIFICATIONS

CSV2000BP-3 Performance Curves



Figure 7: CSV2000BP-3 Turn Off Characteristic via PS_ON
 Load: $I_O = 163.9A$ $I_{SB} = 3.5A$
 Ch 2: PS_ON_L Ch 3: V_O Ch 4: PWOK



Figure 8: CSV2000BP-3 Transient Response - V_O Deviation
 50% to 100% load change $1A/uS$ slew rate $V_{in} = 230Vac$
 Ch 3: V_O Ch 4: I_O

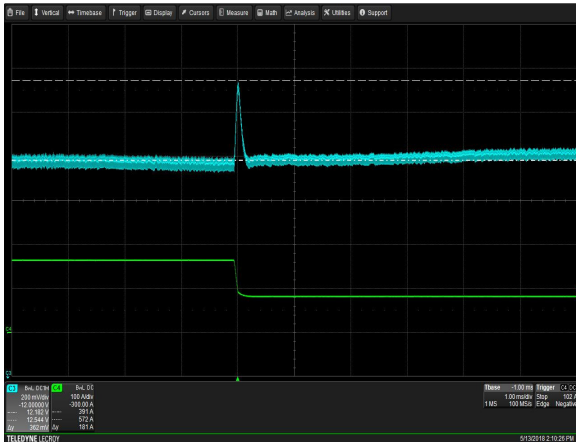

Figure 9: CSV2000BP-3 Transient Response - V_O Deviation
 100% to 50% load change $1A/uS$ slew rate $V_{in} = 230Vac$
 Ch 3: V_O Ch 4: I_O

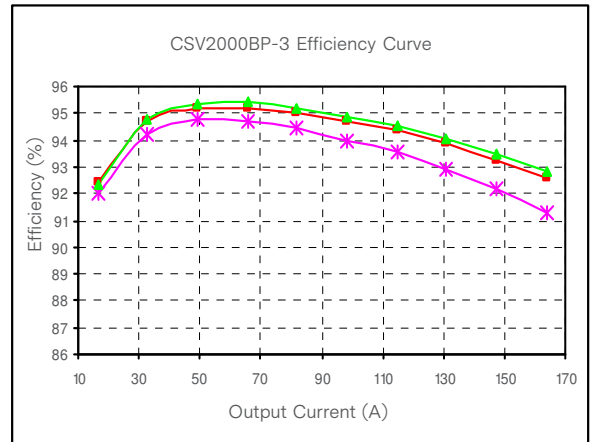

Figure 10: CSV2000BP-3 Efficiency Curve @ 25°C
 * 180Vac ■ 230Vac ▲ 264Vac
 Loading: $I_{o_main} = 10\%I_{o_max}$ increment to 163.9A, $I_{SB} = 3A$

ELECTRICAL SPECIFICATIONS

Protection Function Specifications

Input Fuse

CSV2000BP series power supply is equipped with an internal non user serviceable 16A @ 420Vac/Vdc fuse for fault protection on L line input.

Over Voltage / Under Voltage Protection (OVP / UVP)

The main and standby output is protected against over-voltage according to the limits set in below table. When the main output / standby OVP circuit is activated, the power supply will latch off, require PSON or the input power to be recycled manually to reset the power supply after the fault has been removed.

The power supply main output will shut down if it drops to under-voltage limits below.

OVP

Parameter	Min	Nom	Max	Unit
V _O Output Overvoltage Protection	13.8	/	/	V
V _{SB} Output Overvoltage Protection	13.8	/	/	V

UVP

Parameter	Min	Nom	Max	Unit
V _O Output Under-voltage Protection	/	/	10.0	V
V _{SB} Output Under-voltage Protection	/	/	10.0	V

Over Temperature Protection (OTP)

The power supply is internally protected against over temperature conditions. When the OTP limit is reached, all outputs, except standby, will latch off. Reset can be done by recycling the input or PSON. The power supply will provide a temperature warning to the system whenever there is an impending over-temperature shut down. This will be through the OT_WARN bit of the STATUS_TEMPERATURE command. The power supply will not shut down for 30 seconds after setting the OT_WARN bit. If the over-temperature warning persists after 30 seconds, the power supply will set the THERMAL_FAULT bit of STATUS_MFR_SPECIFIC command, and OT_FAULT bit of STATUS_TEMPERATURE command, and then shut down.

Over Current Protection (OCP)

The main output is internally protected against output overload or short circuit applied to its output. No damage will result to the supply as the result of either short term or long term overloads of the outputs. The overcurrent limit is in below table. The main output will not shut down if the over-current conditions does not last for more than 50ms. Shut down mode is latch.

The standby output will have an OCP limit per below, and will auto-recover when the overload is removed. The standby output will not shut down if the over-current conditions does not last for more than 1ms. An OCP fault on the main output will not cause the standby output to fail.

Parameter	Min	Nom	Max	Unit
V _O Output Overcurrent Protection	95.9	/	/	A
V _{SB} Output Overcurrent	3.9	/	/	A

MECHANICAL SPECIFICATIONS

Mechanical Outlines (unit: mm)

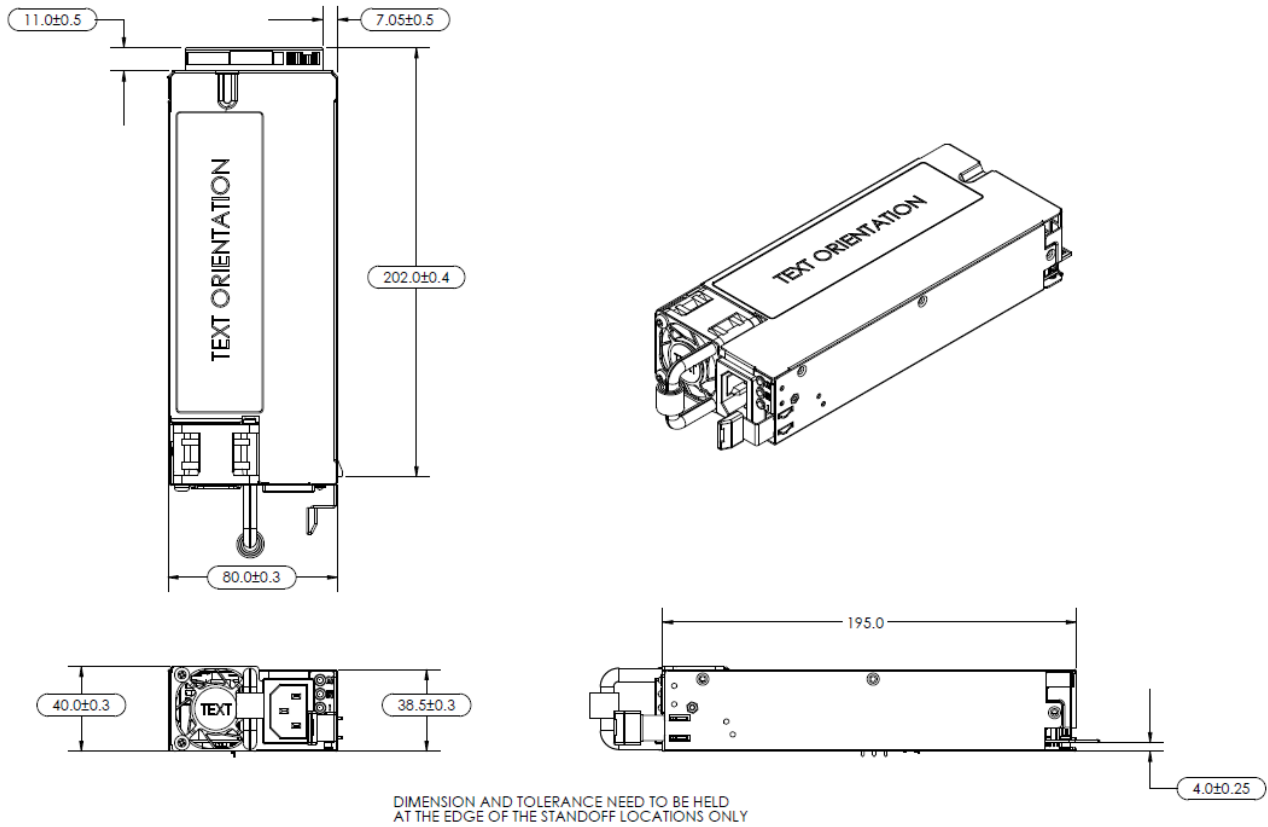

MECHANICAL SPECIFICATIONS

Connector Definitions

AC Input Connector

Pin 1 – Line

Pin 2 – Neutral

Pin 3 – Earth Ground

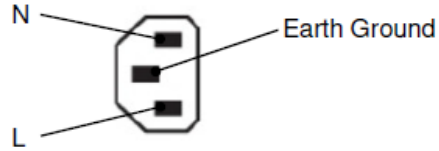

Output Connector - Power Blades

P1-P8 – Main Output (V_O)

P9-P18 – Main Output Return

P19-P20 – Standby Output (V_{SB})

P21-P28 – Main Output Return

P29-P36 – Main Output (V_O)

Power Supply Output Card Edge (Bottom Side)

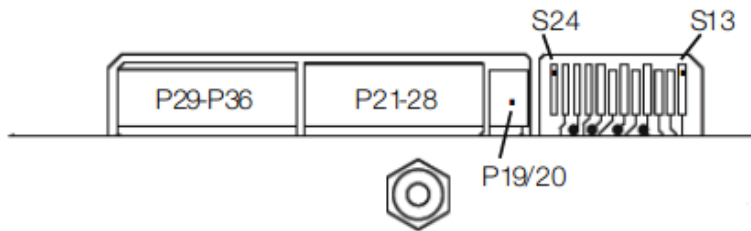

Output Connector - Control Signals

S1 & S2 – RESERVED

S3 – +MAIN_VRS / +Vsense

S4 – RESERVED (GND at system)

S5 – RESERVED

S6 – DC_GOOD / PWOK

S7 – PRESENT

S8 – SMBALERT

S9 – ISHARE

S10 – GND / RETURN

S11 – SDA

S12 – SCL

S13 – SMBUS_RESET

S14 – RESERVED

S15 – ADDRESS

S16 & S17 – PSON_L

S18 – EPOW / ACOK

S19 – RESERVED

S20 – THROTTLE

S21 – RESERVED

S22 – -MAIN_VRS / -Vsense

S23 & S24 – RESERVED

Power Supply Output Card Edge (Top Side)

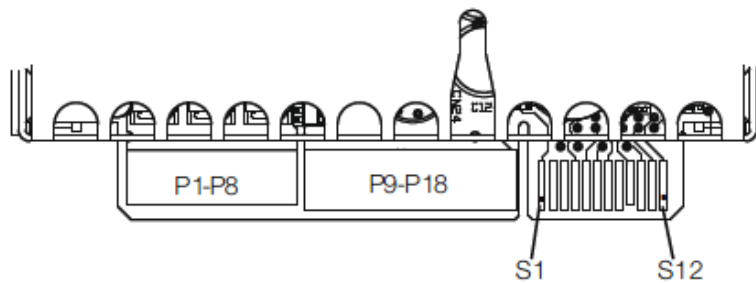

MECHANICAL SPECIFICATIONS

Power / Signal Mating Connectors and Pin Types

Table 5. Mating Connectors for CSV2000BP Series		
Reference	On Power Supply	Mating Connector or Equivalent
AC Input Connector	IEC320-C14	IEC320-C13
Output Connector	Card-edge	FCI Amphenol HPCE 10122238-320424FLF

MECHANICAL SPECIFICATIONS

LED Indicator Definitions

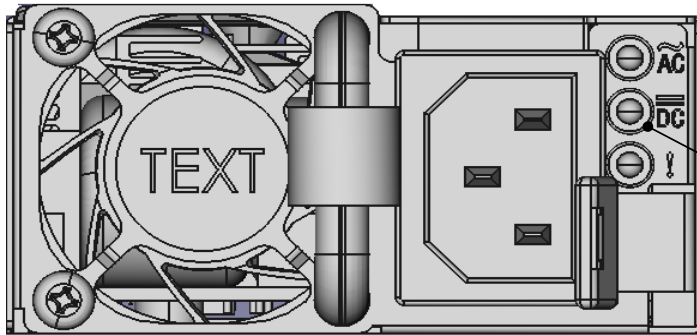

Three LEDs will provide the power supply status. The LED conditions are shown on the below table.

Status LEDs

Conditions	LED Status	Descriptions
Input Good Indicator (AC)	GREEN	This LED indicates the status of the EPOW / ACOK signal. This will be lit GREEN when EPOW / ACOK is de-asserted and the PSU is receiving normal input power.
Output Good Indicator (DC)	GREEN	This LED indicates the status of the DC_GOOD / PWOK signal. This will be lit GREEN when DC_GOOD / PWOK is asserted and the PSU is operating normally.
Fault Indicator	YELLOW	This LED will be lit YELLOW when the power supply has experienced a fault. The state of this LED is OFF when the PSU is operating in normal conditions.

MECHANICAL SPECIFICATIONS

Weight

The CSV2000BP series power supply weight is 1060g/2.34lbs.

ENVIRONMENTAL SPECIFICATIONS

EMC Immunity

CSV2000BP series power supply is designed to meet the following EMC immunity specifications.

Table 6. Environmental Specifications	
Document	Description
EN55032/FCC/CFR47	Radiated Emissions, 30M - 1GHz, Class A
EN55032/FCC/CFR47	Conducted Emissions, 150K - 30MHz, Class A
IEC/EN61000-3-2	Harmonics - AC supply <16A per phase
IEC/EN61000-3-3	Voltage Fluctuations - AC supply <16A per phase
IEC/EN61000-4-2	Electromagnetic Compatibility (EMC) - Testing and measurement techniques - Electrostatic discharge immunity test: 15KV air, 8KV contact discharge. Performance - Criteria B
IEC/EN61000-4-3	Electromagnetic Compatibility (EMC) - Testing and measurement techniques - Radiated, radio-frequency, electromagnetic field immunity test: 10V/m. Performance - Criteria B
IEC/EN61000-4-4	Electromagnetic Compatibility (EMC) - Testing and measurement techniques - Electrical fast transient/burst immunity test: +/- 1.1KV for AC power port. Performance - Criteria B
IEC/EN61000-4-5	Electromagnetic Compatibility (EMC) - Testing and measurement techniques - Surge test: +/-2KV common mode and +/-1KV differential mode for AC ports. Performance - Criteria B
IEC/EN61000-4-6	Electromagnetic Compatibility (EMC) - Testing and measurement techniques - Conducted Immunity 10Vrms. Performance - Criteria A.
EN61000-4-11	Electromagnetic Compatibility (EMC) - Testing and measurement techniques - Voltage dips and interruptions: Criteria B: >95% reduction for 10ms; Criteria B: >30% reduction for 500ms, or Criteria C: >95% reduction for 500ms.

Notes: Performance Criteria as defined by EN55024.

Performance Criteria A: The apparatus shall continue to operate as intended after the test. No degradation of performance or loss of function is allowed below specified performance level during intended use of operation.

Performance Criteria B: The apparatus shall continue to operate as intended after the test. No degradation of performance or loss of function is allowed below specified performance level during intended use of operation. Degradation of performance is allowed during the exposure to an electromagnetic phenomenon but no change of actual operating state is allowed.

Performance Criteria C: Temporary loss of function is allowed, provided the function is self-recoverable or can be restored by the operation of the controls.

ENVIRONMENTAL SPECIFICATIONS

Safety Certifications

The CSV2000BP series power supply is intended for inclusion in other equipment and the installer must ensure that it is in compliance with all the requirements of the end application. This product is only for inclusion by professional installers within other equipment and must not be operated as a stand alone product.

Table 7. Safety Certifications for CSV2000BP Series Power Supply	
Standard	Description
UL60950-1, CAN/CSA C22.2 No.60950-1	US and Canada Requirements
CB Certificate and Report	All CENELEC Countries
CE (LVD+RoHS), EN60950-1	European Requirements
KC	Korea Requirements
CQC	China Requirements
BSMI	Taiwan Requirements
BIS	India Requirements
TUV	European Requirements

ENVIRONMENTAL SPECIFICATIONS

EMI Emissions

The CSV2000BP series power supply has been designed to comply with the Class A limits of EMI requirements of FCC CFR 47 Part 15 Subpart B and the limits specified in CISPR22 / EN55022, and Class A limits of EN300386.

Conducted Emissions

The applicable standard for conducted emissions is FCC 47CFR15 Subpart B (CISPR22/EN55022). Conducted noise can appear as both differential mode and common mode noise currents. Differential mode noise is measured between the two input lines, with the major components occurring at the supply fundamental switching frequency and its harmonics. Common mode noise, a contributor to both radiated emissions and input conducted emissions, is measured between the input lines and system ground and can be broadband in nature.

Line:

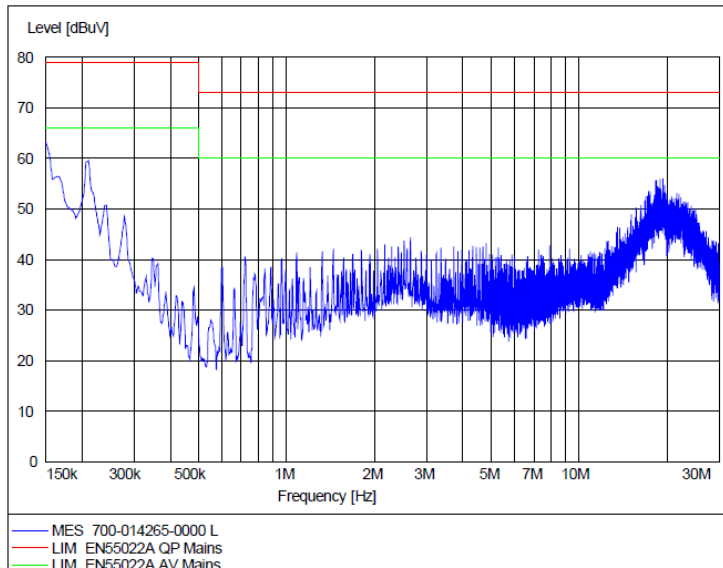

The CSV2000BP series power supply has internal EMI filters to ensure the convertor's conducted EMI levels comply with FCC 47CFR15 Subpart B (CISPR22/EN55022) Class A limits. The EMI measurements are performed with resistive loads at maximum rated loading.

Below is sample of conducted EMI measurement at 230Vac / 50Hz input with full load.

Note: Red Line refers to Artesyn Quasi Peak margin, which is 6dB below the CISPR international limit. Pink Line refers to the Quasi Average margin, which is 6dB below the CISPR international limit.

Conducted EMI emissions specifications of the CSV2000BP series power supply:

Parameter	Model	Symbol	Min	Typ	Max	Unit
FCC Part 15, class A	All	Margin	6	-	-	dB
CISPR 32 (EN55022) class A	All	Margin	6	-	-	dB

ENVIRONMENTAL SPECIFICATIONS

Radiated Emissions

Unlike conducted EMI, radiated EMI performance in a system environment may differ drastically from that in a stand-alone power supply. The shielding effect provided by the system enclosure may bring the EMI level from Class A to Class B. It is thus recommended that radiated EMI be evaluated in a system environment. The applicable standard is EN55032 Class A (FCC Part 15). Testing AC-DC converters as a stand-alone component to the exact requirements of EN55032 can be difficult because the standard calls for 1m lead to be attached to the input and outputs and aligned such as to maximize the disturbance. In such a set-up, it is possible to form a perfect dipole antenna that very few AC-DC converters could pass. However, the standard also states that an attempt will be made to maximize the disturbance consistent with the typical application by varying the configuration of the test sample.

ENVIRONMENTAL SPECIFICATIONS

Operating Temperature

The CSV2000BP series power supplies will start and operate within stated specifications at an ambient temperature from 5°C to 50°C. The maximum operating temperature (50°C) is to be de-rated by 1°C per 600 feet above 3000 feet.

Forced Air Cooling

The CSV2000BP series fan is included as part of the power supply assembly and provide cooling to the power supply. Standard or forward airflow direction is from the DC connector end to the AC end of the power supply. The power supply fan will continue to operate when a power supply fails while connected to a system in redundant mode configuration.

The fan can be powered from the 12V system bus but must ensure that a failed fan will not disrupt the system bus. During a fault mode of the power supply, the fan must maintain at least 2000±15% RPM.

Standby mode and sleep mode operation will require airflow to cool the power supply. The fan will be at least 3000±15% RPM during this mode, except when FFS is asserted.

ENVIRONMENTAL SPECIFICATIONS

Storage and Shipping Temperature

The CSV2000BP series power supply can be stored or shipped at temperatures between -40°C to +70°C and relative humidity from 5% to 100% non-condensing.

Altitude

The CSV2000BP series power supply will operate within specifications at altitudes up to 10,000 feet above sea level. The power supply will not be damaged when stored at altitudes up to 50,000 feet above sea level.

Humidity

The CSV2000BP series power supply can operate within specifications when subjected to a relative humidity from 8% to 93% non-condensing. The power supply can be stored in a relative humidity from 5% to 100% non-condensing.

Vibration

The CSV2000BP series power supply will pass the following vibration specifications:

Non-Operating Random Vibration

Acceleration	3.13	gRMS	
Frequency Range	5 - 500	Hz	
Duration	30	Mins	
Direction	6 mutually perpendicular axis		
PSD Profile	FREQ (Hz)	SLOPE (db/oct)	PSD (g ² /Hz)
	5	/	0.000595
	50	/	0.03
	500	/	0.0585

Operating Random Vibration

Acceleration	0.63	gRMS	
Frequency Range	5 - 500	Hz	
Duration	10	Mins	
Direction	3 mutually perpendicular axis		
PSD Profile	FREQ (Hz)	SLOPE (db/oct)	PSD (g ² /Hz)
	5	/	0.000882
	50	/	0.000882
	500	/	0.0004332

ENVIRONMENTAL SPECIFICATIONS

Shock

The CSV2000BP series power supply will pass the following vibration specifications:

Non-Operating Half-Sine Shock

Acceleration	60	G
Duration	11	mSec
Pulse	Square pulse	
Number of Shock	1 time on all 6 faces	

POWER AND CONTROL SIGNAL DESCRIPTIONS

AC Input Connector

This connector supplies the AC Mains to the CSV2000BP series power supply.

- Pin 1 – L
- Pin 2 – N
- Pin 3 – Earth Ground

Output Connector – Power Blades

These pins provide the main output for the CSV2000BP series power supply. The Main Output (V_O) and the Main Output Return pins are the positive and negative rails, respectively, of the V_O main output of the CSV2000BP series power supply. The Main Output (V_O) is electrically isolated from the power supply chassis.

- P1-P8 – Main Output (V_O)
- P9-P18 – Main Output Return
- P19-P20 – Standby Output (V_{SB})
- P21-P28 – Main Output Return
- P29-P36 – Main Output (V_O)

Output Connector – Control Signals

The CSV2000BP series power supply contains a 14 pins control signal header providing an analogue control interface, standby power and I²C interface signal connections.

+MAIN_VRS / +Vsense , -MAIN_VRS / -Vsense - (Pin S3, S22)

The power supply main output is equipped with remote sense on the +MAIN_VRS / +Vsense and -MAIN_VRS / -Vsense pins. The remote sense lines are terminated for local voltage sensing only, thus may not be terminated in the system. This remote sense circuit can compensate for a power path drop of up to 500mV. This remote sense circuit will not raise the power supply's output voltage to the OVP trip level.

DC_GOOD / PWOK - (Pin S6)

An active high DC power good signal will be asserted, driven HIGH, by the power supply to indicate that the main output is valid and operating normally. A low state will indicate that a fault in the power supply has occurred and the main output will shut down and latch off.

Pull-up to 3.3V or 5V must be provided at the system side. A decoupling capacitor of at least 10nF at the system side is recommended.

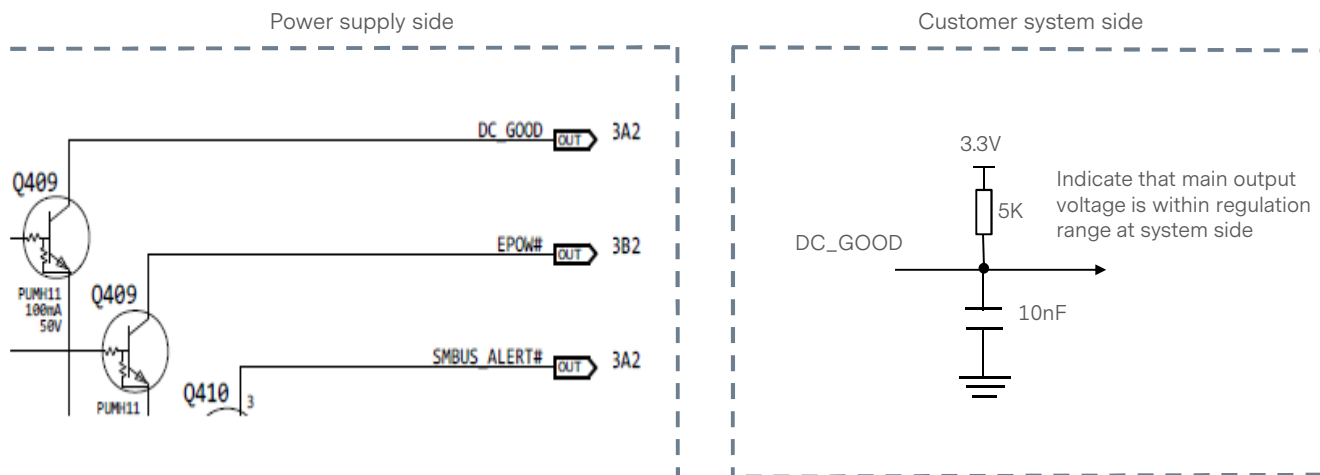

POWER AND CONTROL SIGNAL DESCRIPTIONS

PRESENT - (Pin S7)

This active low signal can be used to sense PSUs physically present in the system. This signal pin is grounded inside the power supply. The host system must pull this signal by using a suitable pull-up to 3.3V or 5V on the system side.

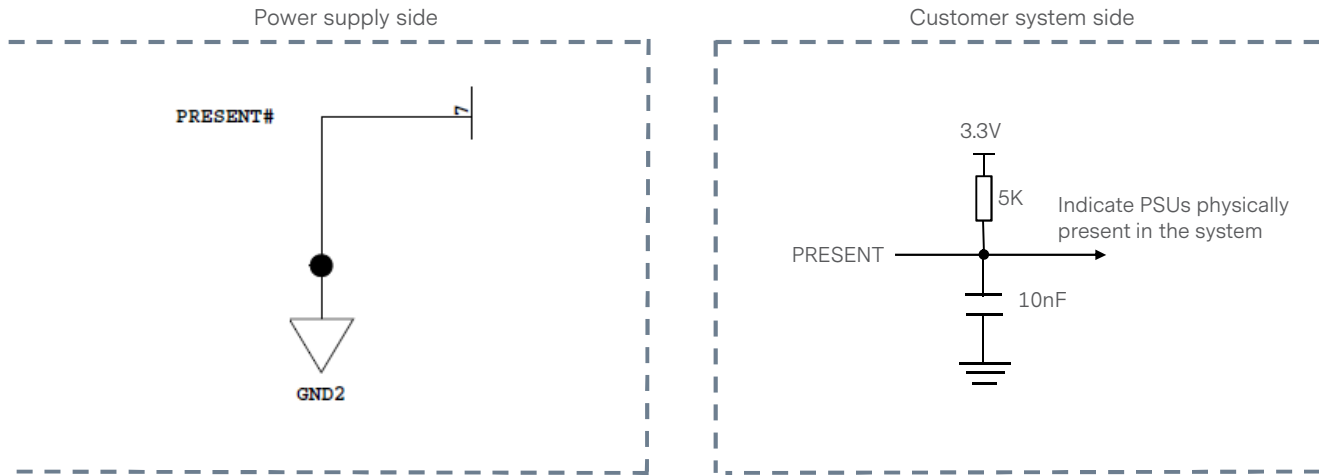

SMBALERT - (Pin S8)

SMBALERT is an active low open collector signal from the power supply to indicate any change in the status of the power supply. A low signal will indicate that one or more non-masked bits in any of the status registers has been set.

Assertion of this signal by the power supply will only occur when the main output is enabled. It will stay de-asserted in standby mode even when any bit in the status registers get set.

The host system shall provide a pull-up to 3.3V or 5V at the system side.

a) Assertion Events

SMBALERT shall generally be asserted when:

- EPOW / ACOK is asserted
- An over-temperature warning has occurred
- The overload condition
- Any non-masked status bit is asserted
- Any level-detected unmasked event has occurred

Whenever a level-detected unmasked even is present, SMBALERT shall be asserted and continue to be asserted as long as the event is present.

b) Resetting

Clearing and resetting of SMBALERT shall be by:

- Clearing of STATUS bits that caused the assertion of the signal
- PSON or input recycling
- Masking the event with SMBALERT_MASK

c) SMBUS Behavior

The SMBALERT behavior for this power supply shall support Intel's Node Manager. Refer to the flowchart below.

POWER AND CONTROL SIGNAL DESCRIPTIONS

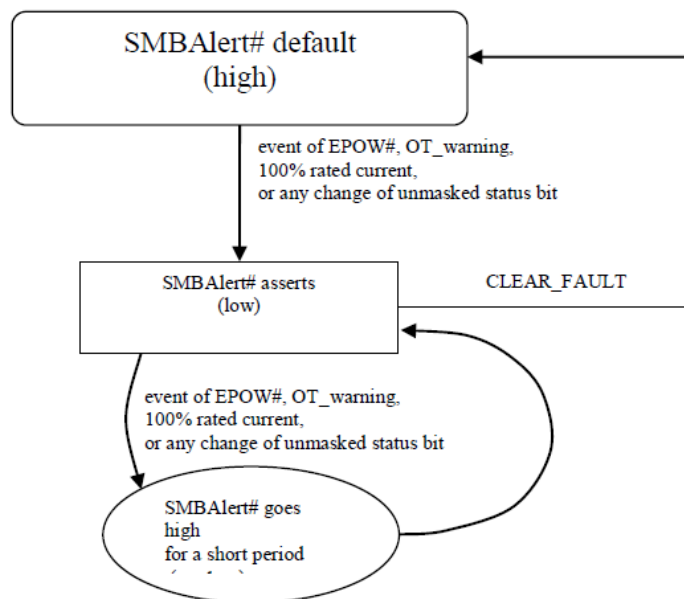
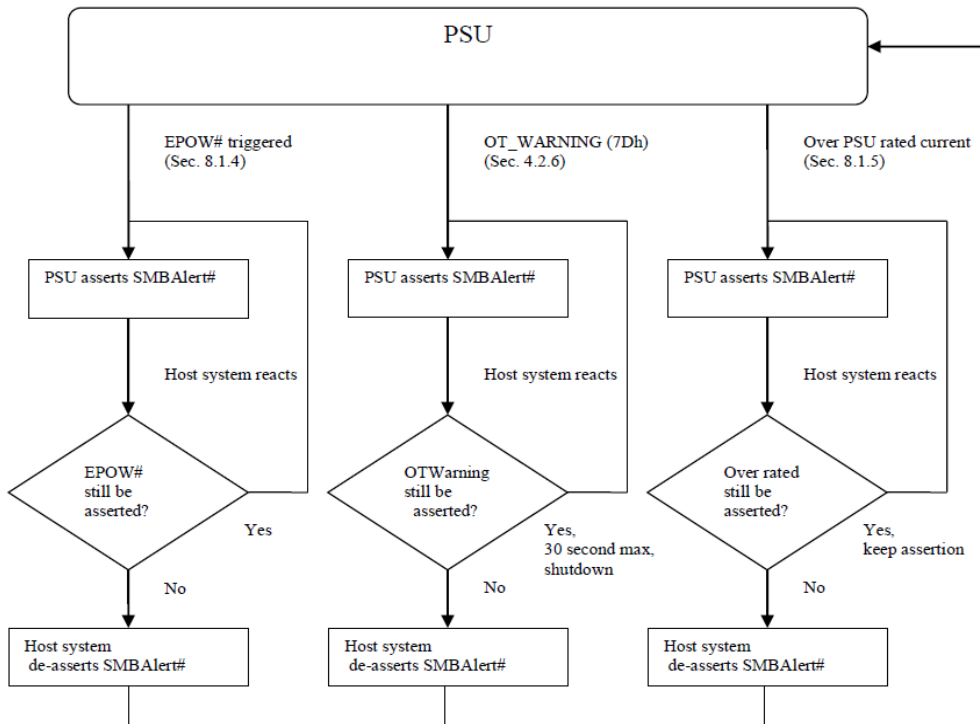

POWER AND CONTROL SIGNAL DESCRIPTIONS

ISHARE (Current Share Bus) - (Pin S9)

This signal is a bus which will allow two or more power supplies to share the system load current.

This signal will have a voltage which is directly proportional to supplied current. A linear slope from minimum load to full load is expected.

SMBUS_RESET - (Pin S13)

SMBUS_RESET is an active low input signal to reset all SMBUS interfaces within the power supply. The system may drive this signal low between 1us to 500ms.

The power supply shall provide a pull-up to this signal. The host system will have an open collector device for this signal.

PSON_L - (Pin S16, S17)

This signal is active low signal, enables or disables the 12V main output of the power supply. When the signal is pulled low (<0.8V) by the system and EPOW is high, the 12V main output will be enabled. The standby output is not affected by this signal.

EPOW / ACOK - (Pin S18)

The EPOW / ACOK is an active low open collector signal which is normally HIGH (>2.0V) whenever input AC voltage is within allowable limits. This signal will go LOW (<0.8V) when the input has gone below or above the operating limit. Pull-up on system side is required. A suitable decoupling capacitor connected to the return line is recommended on system side.

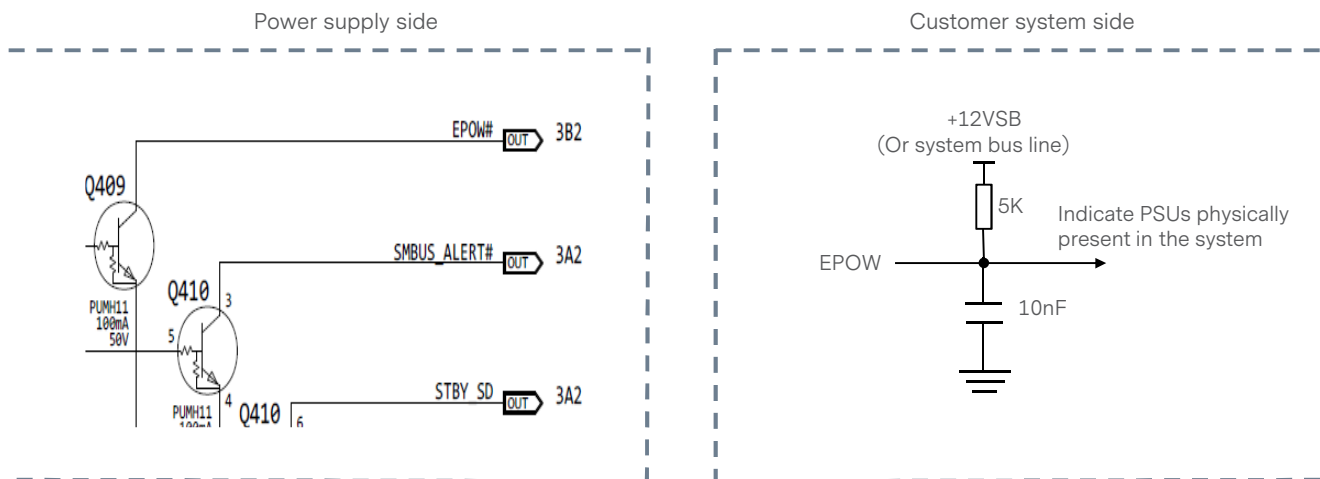

POWER AND CONTROL SIGNAL DESCRIPTIONS

THROTTLE - (Pin S20)

THROTTLE is an active low open collector signal that indicates to the system host that it needs to reduce its power consumption or risk having a shutdown event. This signal is triggered by an oversubscription of the load beyond the maximum current rating or by an over-temperature warning. Upon assertion, this signal remains asserted until the system reduces the load it draws or the OT_WARNING status has been cleared. If the oversubscription of the load goes beyond 5 secs, the power supply shall shut down and flag the oversubscription fault bit.

Output current thresholds and timings are provided in below table.

Output Oversubscription (Slew rate not more than 0.5A/us)				
Conditions	Min	Nom	Max	Unit
Maximum absolute current, I_{MAX} *5 sec ride-through time before power supply is allowed to shut down if the load does not go below 70.1A.	-	-	213	A
Threshold for THROTTLE# asserted ($I_{throttle_Lo}$)*assertion delay of 1ms upon hitting the threshold.	-	172	-	A
Threshold for THROTTLE# deasserted ($I_{throttle_Hi}$)*deassertion delay of 1ms upon hitting the threshold.	-	156	-	A

The power supply does not have a pull-up for this signal. The host system must provide the pull-up to 3.3V or 5V at the system side.

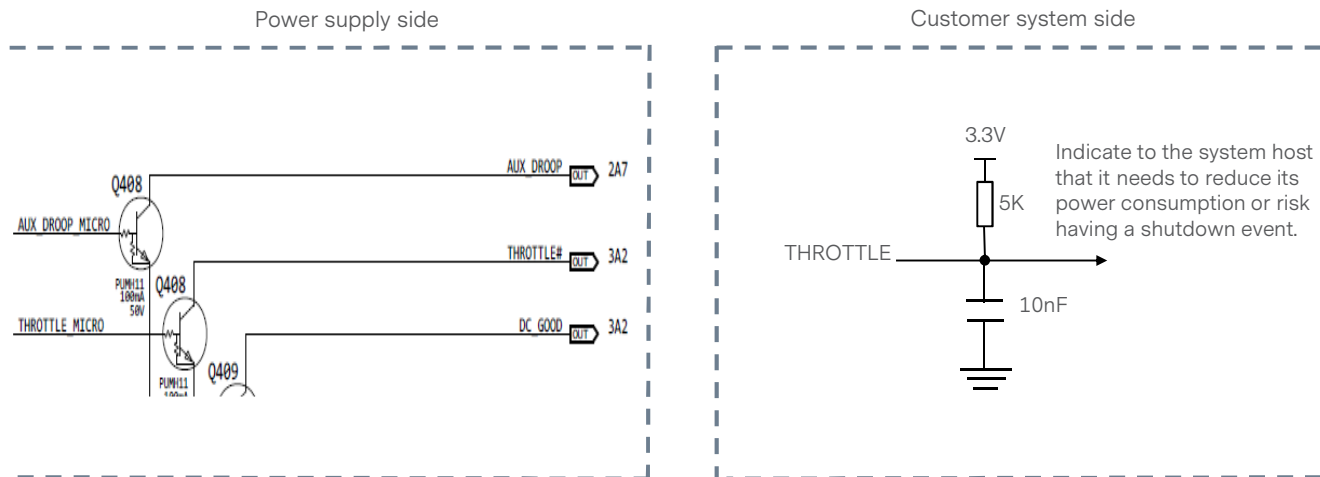

THROTTLE Flowchart:

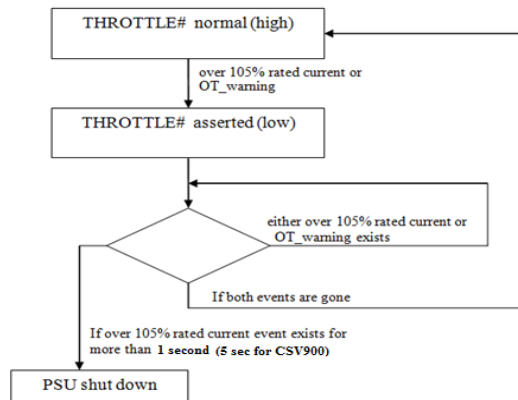

COMMUNICATION BUS DESCRIPTIONS

I²C Bus Signals

CSV2000BP series power supply contains enhanced monitor and control functions implemented via the I²C bus. The CSV2000BP series I²C functionality (PMBus™ and FRU data) can be accessed via the output connector control signals. The communication bus is powered either by the internal 3.3V supply or from an external power source connected to the standby output (i.e. accessing an unpowered power supply as long as the standby output of another power supply connected in parallel is on).

If units are connected in parallel or in redundant mode, the standby outputs must be connected together in the system. Otherwise, the I²C bus will not work properly when a unit is inserted into the system without the DC source connected.

Note: PMBus™ functionality can be accessed only when the PSU is powered-up. Guaranteed communication I²C speed is 100KHz.

SDA, SCL (I²C Data and Clock Signals) - (Pin S11, S12)

SDA and SCL are bi-directional serial bus lines for communication for SMBus devices in the power supply and the host system.

These pins for I²C communication must be pulled up in the system. The power supply doesn't have internal pull-ups. These pins are recommended to be pulled up in the system by an 2.2K ohm resistor to 3.3V and a 200pF decoupling capacitor at the system side.

I²C Bus Communication Interval

The interval between two consecutive I²C communications to the power supply must be at least 15ms to ensure proper monitoring functionality.

I²C Bus Signal Integrity

The noise on the I²C bus (SDA, SCL lines) due to the power supply will be less than 300mV peak-to-peak. This noise measurement should be made with an oscilloscope bandwidth limited to 100MHz. Measurements must be made at the power supply output connector with 10Kohm resistors pulled up to 3.3V source and a decoupling 47pF ceramic capacitors to standby output return.

ADDRESS (I²C Address Signal) - (Pins S15)

ADDRESS is an analog signal to assign the serial bus 8-bit address. The power supply will attach a 40.2Kohm $\pm 1\%$ resistor between 12Vaux and this signal pin. The host system shall have a 1% resistor between this signal pin and return, right at the power supply connector. The two resistors set up a voltage divider circuit that the power supply will use to determine the address. See table 8 for the power supply addresses.

COMMUNICATION BUS DESCRIPTIONS

I²C Bus Internal Implementation, Pull-ups and Bus Capacitances

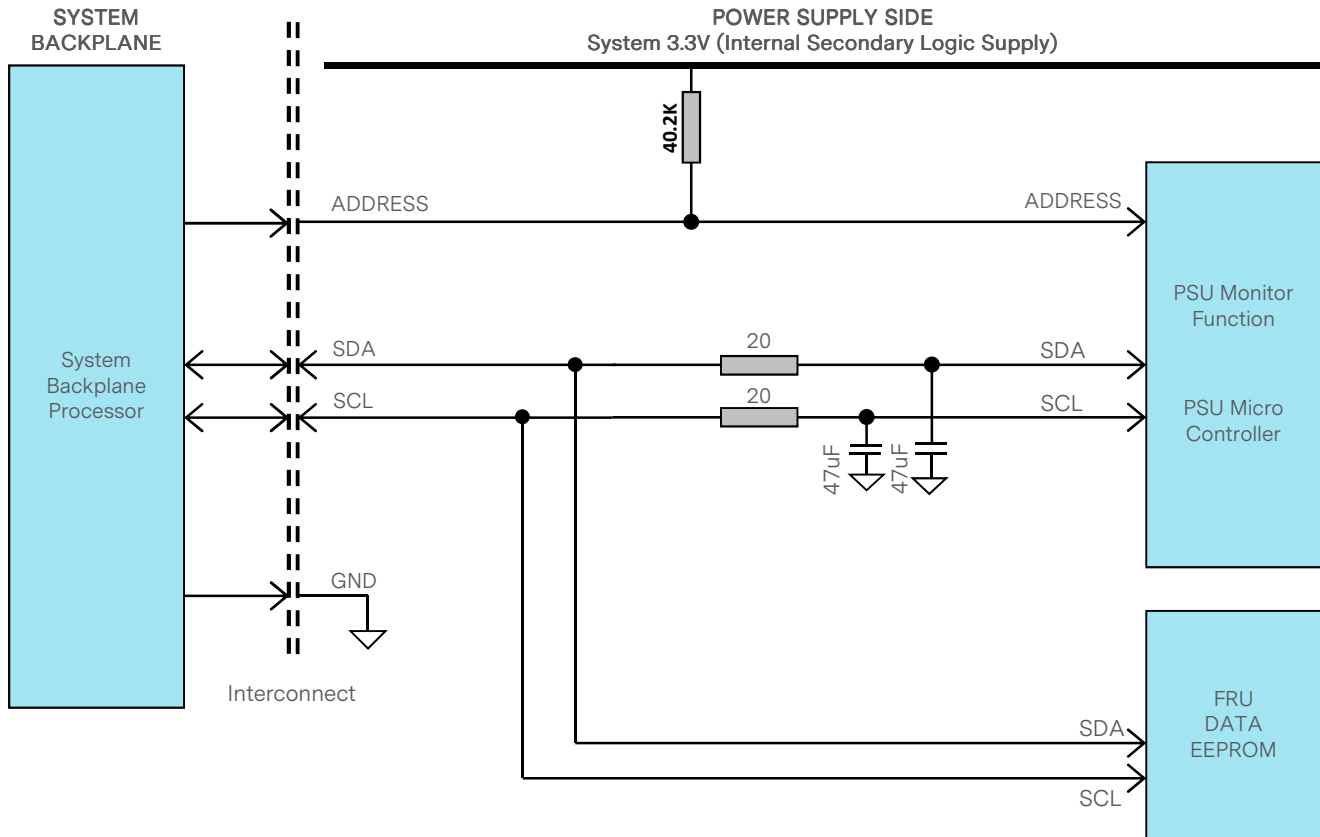

I²C Bus - Recommended external pull-ups

Electrical and interface specifications of I²C signals (referenced to standby output return pin, unless otherwise indicated):

Parameter	Condition	Symbol	Min	Type	Max	Unit
SDA, SCL Internal Pull-up Resistor		R_{int}	No internal pull-up resistor			
SDA, SCL Recommended External Bus Capacitance		C_{ext}	-	200	-	pF
Recommended External Pull-up Resistor	1 PSU	R_{ext}	-	2.2	-	Kohm

COMMUNICATION BUS DESCRIPTIONS

Logic Levels

CSV2000BP series power supply I²C communication bus will respond to logic levels as per below:

Logic High: 3.3V nominal (Spec is 2.1V to 5.5V)**

Logic Low: 500mV nominal (Spec is 2000mV max)**

**Note: Artesyn 73-769-001 I²C adapter was used.

Timings

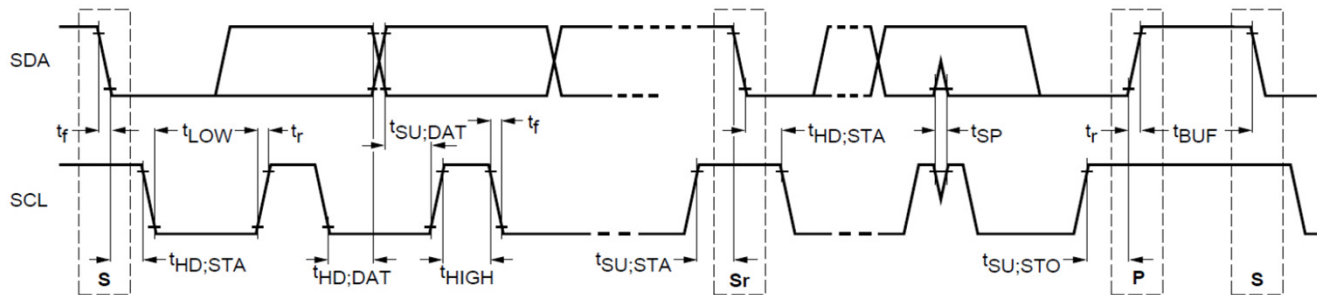

Parameter	Symbol	Standard-Mode Specs		Actual Measured		Unit
		Min	Max			
SCL clock frequency	f_{SCL}	10	100	90.9		KHz
Hold time (repeated) START condition	$t_{HD,STA}$	4.0	-	4.74		uS
LOW period of SCL clock	t_{LOW}	4.7	-	4.86		uS
HIGH period of SCL clock	t_{HIGH}	4.0	50	4.84		uS
Setup time for repeated START condition	$t_{SU,STA}$	4.7	-	4.884		uS
Data hold time	$t_{HD,DAT}$	0	-	0.2416		uS
Data setup time	$t_{SU,DAT}$	250	-	4887		nS
Rise time	t_r	-	1000	SCL = 669.6	SDA = 710.4	nS
Fall time	t_f	-	300	SCL = 156.8	SDA = 146	nS
Setup time for STOP condition	$t_{SU,STO}$	4.0	-	5.02		uS
Bus free time between a STOP and START condition	t_{BUF}	4.7	-	95***		uS

***Note: Artesyn 73-769-001 I²C adapter (USB-to-I²C) and Universal PMBus™ GUI software was used.

COMMUNICATION BUS DESCRIPTIONS

Device Addressing

The CSV2000BP power supply has a $40.2\text{k}\Omega \pm 1\%$ resistor pull-up to 12Vsb. The host system shall have a resistor from this pin to return right at the power supply connector. The voltage resulting from this divider shall determine the power supply address based on table 8.

ADDRESS pin (Pin S15) is an analog signal to assign the serial bus 8-bit address.

Table 8: Device Addressing

Resistance ¹ (Ohms)	Resultant Voltage ² (V)	Address ³	
		Binary	Hex
Open	12.00	1101 0000	D0
280k	10.49	1101 0010	D2
121k	9.01	1101 0100	D4
68.1k	7.55	1101 0110	D6
40.2k	6.00	1101 1000	D8
23.7k	4.45	1101 1010	DA
13.3k	2.98	1101 1100	DC
5.76k	1.50	1101 1110	DE

Note 1 - Host system resistors, $\pm 1\%$ tolerance or better.

Note 2 - Based on average resistor and 12Vsb values.

Note 3 - The power supply must reply to commands sent with the 8-bit address.

COMMUNICATION BUS DESCRIPTIONS

I²C Clock Synchronization

The CSV2000BP series power supply applies clock stretching. An addressed slave power supply holds the clock line (SCL) low after receiving (or sending) a byte, indicating that it is not yet ready to process more data. The system master that is communicating with the power supply will attempt to raise the clock to transfer the next bit but must verify that the clock line was actually raised. If the power supply is clock stretching, the clock line will still be low (because the connections are open-drain).

The maximum time-out condition for clock stretching for CSV2000BP series is 100 milliseconds.

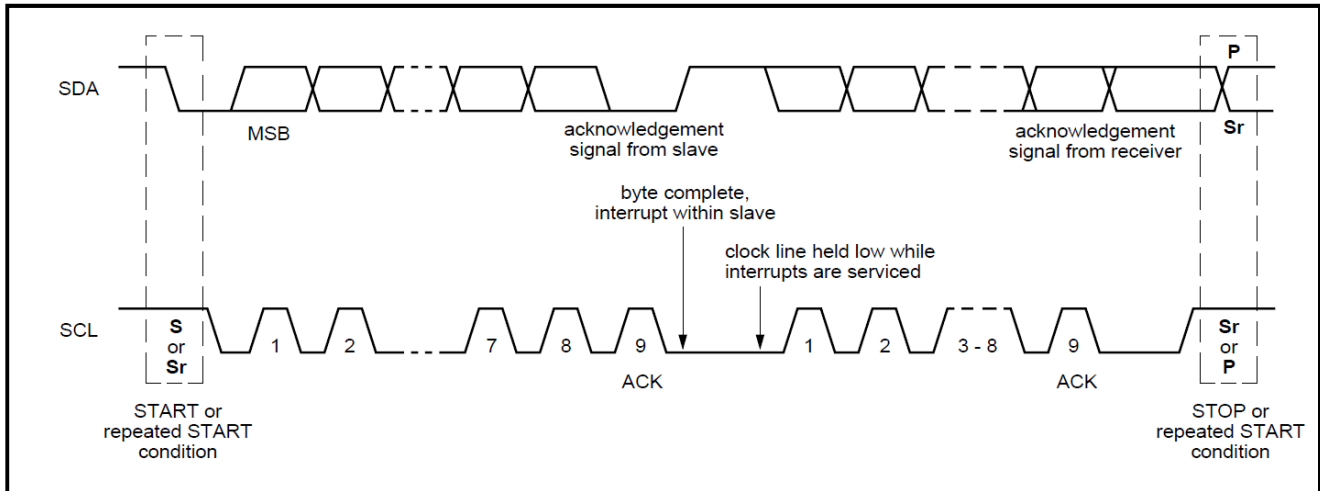

PMBus™ SPECIFICATIONS

The CSV2000BP series is compliant with the industry standard PMBus™ protocol for monitoring and control of the power supply via the I²C interface port.

CSV2000BP Series PMBus™ General Instructions

Equipment Setup

The following is typical I²C communication setup:

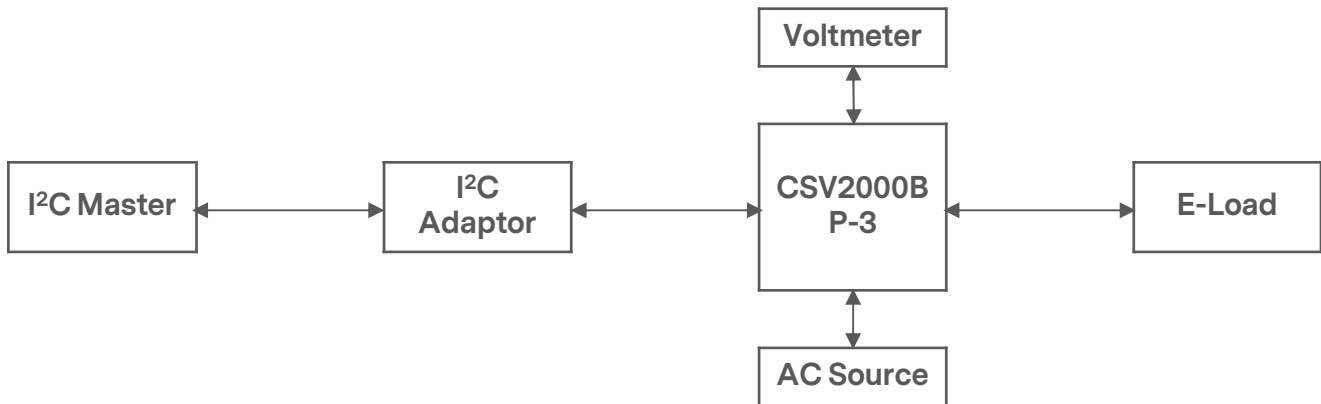

PMBus™ SPECIFICATIONS

The CSV2000BP Series Supported PMBus™ Command List:

Command Code	Command Name	Default Value	Access Type	Data Bytes	Data Format	Description
00h	PAGE	00	R	1	Hex	Only Read is supported.
01h	OPERATION	80	R/W	1	Bitmapped	Used to turn the unit ON/OFF.
	b7:6	10				01 - Immediate turn OFF (No sequencing) 10 - PSU ON Margining not supported.
	b5:0	00000				Reserved
02h	ON_OFF_CONFIG	1C	R	1	Bitmapped	Configures the combination of CONTROL pin and serial communication commands needed to turn the unit ON/OFF.
	b7:5					Reserved
	b4 - Enable CONTROL pin and serial communication control.	1				0 - Unit powers up any time power is present regardless of the state of CONTROL pin. 1 - Unit powers up as dictated by CONTROL pin and OPERATION command (b3:0).
	b3 - Serial communication control	1				0 - Unit ignores ON/OFF portion of the OPERATION command. 1 - Enables serial communication ON/OFF portion of OPERATION command. Requires CONTROL pin to be asserted for the unit to start and energize the output.
	b2 - Sets how the unit responds to CONTROL pin	1				0 - Unit ignores CONTROL pin. (ON/OFF controlled by OPERATION command). 1 - Unit requires CONTROL pin to be asserted to start the unit.
	b1 - CONTROL pin polarity	0				0 - Active low (Pull low to start the unit) 1 - Active high (Pull high to start the unit)
	b0 - CONTROL pin action	0				0 - Use programmed turn ON/OFF delay. 1 - Turn OFF the output and stop transferring energy to the output as fast as possible.
03h	CLEAR_FAULTS		S			
05h	PAGE_PLUS_WRITE	00	BW	Varies		
06h	PAGE_PLUS_READ	00	BR/BW	Varies		

PMBus™ SPECIFICATIONS

The CSV2000BP Series Supported PMBus™ Command List:

Command Code	Command Name	Default Value	Access Type	Data Bytes	Data Format	Description
19h	CAPABILITY	90	R	1	Bitmapped	Provides a way for the hosts system to determine some key capabilities of a PMBus™ device.
	b7 - Packet Error Checking					0 - PEC not supported 1 - PEC supported
	b6 - Maximum Bus Speed					0 - Maximum supported bus speed, 100KHz 1 - Maximum supported bus speed, 400KHz
	b5 - SMBALERT					0 - SMBus Alert Pin not supported. 1 - SMBus Alert Pin supported.
	b4:0					Reserved
1Ah	QUERY	-	BR/BW		N/A	Used to determine if the PSU supports a specific command; It should return the proper information about any commands listed.
1Bh	SMBALERT_MASK		BR/BW		N/A	Used with STATUS_INPUT, STATUS_TEMPERATURE, STATUS_IOUT.
20h	VOUT_MODE	17	R	1	Bitmapped	Specifies the mode and parameters of output voltage related data formats.
30h	COEFFICIENTS		BW/BR	5	Hex	Use to retrieve the m, b and R coefficients, needed for DIRECT data format.
	byte 5	00				R byte
	byte 4:3	0000				b low byte, b high byte
	byte 2:1	0001				m low byte, m high byte
3Ah	FAN_CONFIG_1_2	90	R	1	Bitmapped	
	b7	1				0 - No fan is installed in position 1. 1 - Fan is installed in position 1.
	b6	0				0 - Fan is commanded in RPM. 1 - Fan is commanded is DC.
	b5:4	01				00 - 1 pulse per revolution 01 - 2 pulses per revolution 10 - 3 pulses per revolution 11 - 4 pulses per revolution
	b3:0	0000				Reserved
3Bh	FAN_COMMAND_1		R/W	2	Linear	Adjusts the operation of the fans. The device may override the command, if it requires higher value, to maintain proper device temperature. Duty cycle control - commands speeds from 0 to 100%.
4Ah	IOUT_OC_WARN_LIMIT		R/W	2	Linear	Sets the output over current warning threshold in Amps.
51h	OT_WARN_LIMIT(Hot Spot)		R	2	Hex	Secondary ambient temperature warning threshold, in degree C. Operating limit

PMBus™ SPECIFICATIONS

The CSV2000BP Series Supported PMBus™ Command List:

Command Code	Command Name	Default Value	Access Type	Data Bytes	Data Format	Description
78h	STATUS_BYTE		R	1		Returns the summary of critical faults.
	b7 - BUSY					A fault was declared because the device was busy and unable to respond.
	b6 - OFF					Unit is OFF.
	b5 - VOUT_OV					Output over-voltage fault has occurred.
	b4 - IOUT_OC					Output over-current fault has occurred.
	b3 - VIN_UV					An input under-voltage fault has occurred.
	b2 - TEMPERATURE					A temperature fault or warning has occurred.
	b1 - CML					A communication, memory or logic fault has occurred.
	b0 - NONE OF THE ABOVE					A fault warning not listed in bits[7:1] has occurred.
79h	STATUS_WORD		R	2	Bitmapped	Summary of units fault and warning status.
	b15 - VOUT					An output voltage fault or warning has occurred.
	b14 - IOUT					An output current or power fault or warning has occurred.
	b13 - INPUT					An input voltage, current or power fault or warning as occurred.
	b11 - POWER_GOOD#					The POWER_GOOD signal is de-asserted.
	b10 - FANS					A fan or airflow fault or warning has occurred.
	b6 - OFF					Unit is OFF.
	b4 - IOUT_OC					Output over-current fault has occurred.
	b3 - VIN_UV					An input under-voltage fault has occurred.
	b2 - TEMPERATURE					A temperature fault or warning has occurred.
	b1 - CML					A communication, memory or logic fault has occurred.
	b0 - NONE OF THE ABOVE					A fault warning not listed in bits[7:1] has occurred.
7Ah	STATUS_VOUT		R	1	Bitmapped	
	b7 - VOUT Over-voltage Fault					VOUT Over-voltage fault
	b4 - VOUT Under-voltage Fault					VOUT Under-voltage fault

PMBus™ SPECIFICATIONS

The CSV2000BP Series Supported PMBus™ Command List:

Command Code	Command Name	Default Value	Access Type	Data Bytes	Data Format	Description
7Bh	STATUS_IOUT		R	1	Bitmapped	
	b7 - IOUT Overcurrent Fault					IOUT Overcurrent fault
	b5 - IOUT Overcurrent Warning					IOUT Overcurrent warning
	b3 - Current Share Fault					Current Share Fault
	b1 - POUT_OP_FAULT					POUT_OP_FAULT
	b0 - POUT_OP_WARNING					POUT_OP_WARNING
7Ch	STATUS_INPUT		R	1	Bitmapped	Input related faults and warnings
	b5 - VIN_UV_WARNING					VIN under voltage warning
	b4 - VIN_UV_FAULT					VIN under-voltage fault
	b3 - Unit Off for Low Input Voltage					Unit is OFF for insufficient input voltage.
	b1 - IIN_OC_WARNING					IIN Overcurrent warning
	b0 - POUT_OP_WARNING					POUT_OP_WARNING
7Dh	STATUS_TEMPERATURE		R	1	Bitmapped	Temperature related faults and warnings
	b7 - Over Temperature Fault					Over temperature fault
	b6 - Over Temperature Warning					Over temperature warning
7Eh	STATUS_CML		R	1	Bitmapped	Communications, logic and memory
	b7 - Invalid / Unsupported command					Invalid or unsupported command Received
	b6 - Invalid / Unsupported Data					Invalid data
	b5 - Packet Error Check Failed					Packet error check failed
	b1 - Other Communication Faults					Other Communication Faults
80h	STATUS_MFR_SPECIFIC		R	1	Bitmapped	
	b7 - Current Share Warning					Current share warning
	b6 - 12Vaux Under-voltage or Over-current Fault					12Vaux under-voltage or overcurrent fault
	b5 - 12V Over-current Fault					12V Over-current Fault
	b4 - 12Vaux Over-voltage Fault					12Vaux Over-voltage Fault
	b3 - 12V Under-voltage Fault					12V Under-voltage Fault
	b2 - 12V Over-voltage Fault					12V Over-voltage Fault
	b1 - Thermal Fault					Thermal Fault
b0 - Fan Fault					Fan Fault	
81h	STATUS_FANS_1_2		R	1	Bitmapped	
	b7 - Fan1 Fault					Fan1 Fault
	b5 - Fan1 Warning					Fan1 Warning
86h	READ_EIN		BR	6		Returns the accumulated input power over time.
87h	READ_EOUT		BR	6		Returns the accumulated output power over time.
88h	READ_VIN		R	2	Linear	Returns input voltage in Volts ac.
89h	READ_IIN		R	2	Linear	Returns input current in Amperes.

PMBus™ SPECIFICATIONS

The CSV2000BP Series Supported PMBus™ Command List:

Command Code	Command Name	Default Value	Access Type	Data Bytes	Data Format	Description
8Bh	READ_VOUT		R	2	Linear	Returns the actual, measured voltage in Volts.
8Ch	READ_IOUT		R	2	Linear	Returns the output current in amperes.
8Dh	READ_TEMPERATURE_1 (Ambient)		R	2	Linear	Returns the ambient temperature in degree Celsius.
8Eh	READ_TEMPERATURE_2 (Hot Spot)		R	2	Linear	Returns the hot spot 1 temperature in degree Celsius.
8Fh	READ_TEMPERATURE_3		R	2	Linear	
90h	READ_FAN_SPEED_1		R	2	Linear	Speed of fan 1
96h	READ_POUT		R	2	Linear	Returns the output power, in Watts.
97h	READ_PIN		R	2	Linear	Returns the input power, in Watts.
98h	PMBUS_REVISION		R	1	Bitmapped	Reads the PMBus revision number.
99h	MFR_ID		BR, ASCII	4		Abbrev or symbol of manufacturers name.
9Ah	MFR_MODEL		BR, ASCII	15		Manufacturers model number, ASCII format
9Bh	MFR_REVISION		BR, ASCII	2		Manufacturers, revision number, ASCII format
9Ch	MFR_LOCATION		BR, ASCII	16		Manufacturers facility, ASCII format
9Dh	MFR_DATA		BR	6		Manufacture date (YYYYMMDD)
9Eh	MFR_SERIAL		BR	13		Unit serial number, ASCII format.
9Fh	APP_PROFILE_SUPPORT		BR			
A6h	MFR_IOUT_MAX		R	2	Linear	Maximum output current
A7h	MFR_POUT_MAX		R	2	Linear	Maximum output power
C0h	MFR_MAX_TEMP_1 (Ambient)		R	2	Linear	Maximum ambient temperature
C1h	MFR_MAX_TEMP_2 (hot Spot)		R	2	Linear	Maximum hot spot temperature
C2h	MFR_MAX_TEMP_3		R	2	Linear	
FBh	PRIMARY_FW_REVISION		R	1		
FCh	SECONDARY_FW_VERSION		R	1		
E1h	READ_PIN_AVG		R	2		

APPLICATION NOTES

Current Sharing

The CSV2000BP series main output V_O is equipped with current sharing capability. When two or more power supplies are connected and operating in parallel, the sharing accuracy between units must be within the limits specified in the table below.

The power supply supports up to 3+1 configuration. Current sharing below 30% load per unit is not required.

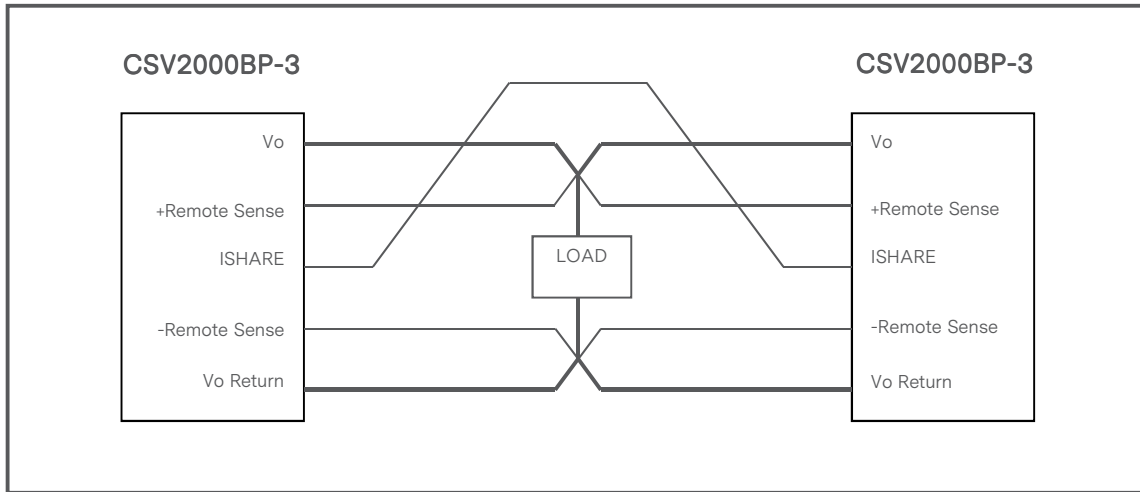

Table 9: Current Sharing Accuracy

Load (per power supply unit)	Max Difference between PSUs
30% - 100%	±10% of expected average from each
50% - 100%	±6% of expected average from each

The current share signal Ishare, is a DC signal that represents the load current that a power supply is providing. This voltage shall increase proportionately with the output load. The typical Ishare voltage is specified in below table.

Table 10: Ishare Voltage

Load (per power supply unit)	Ishare Voltage (V)		
	Min.	Typ.	Max.
100%	4.5	5.0	5.5
50%	2.5	2.5	3.0
25%	0.8	1.25	1.65

APPLICATION NOTES

Output Ripple and Noise Measurement

The setup outlined in the diagram below has been used for output voltage ripple and noise measurements on the CSV2000BP series. When measuring output ripple and noise, a scope jack in parallel with a 0.1 μ F ceramic chip capacitor, and a 10 μ F tantalum capacitor will be used. Oscilloscope can be set to 20MHz bandwidth for this measurement.

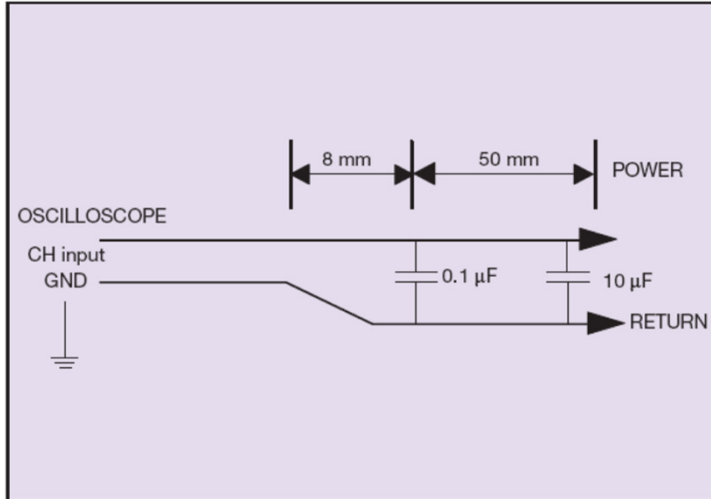

RECORD OF REVISION AND CHANGES

Issue	Date	Description	Originators
1.0	07.20.2018	First Issue	E. Wang
1.1	03.02.2021	Update cover and back cover	C. Liu



For international contact information,
visit advancedenergy.com.

powersales@aei.com (Sales Support)
productsupport.ep@aei.com (Technical Support)
+1 888 412 7832

ABOUT ADVANCED ENERGY

Advanced Energy (AE) has devoted more than three decades to perfecting power for its global customers. AE designs and manufactures highly engineered, precision power conversion, measurement and control solutions for mission-critical applications and processes.

Our products enable customer innovation in complex applications for a wide range of industries including semiconductor equipment, industrial, manufacturing, telecommunications, data center computing, and medical. With deep applications know-how and responsive service and support across the globe, we build collaborative partnerships to meet rapid technological developments, propel growth for our customers, and innovate the future of power.

PRECISION | POWER | PERFORMANCE

Specifications are subject to change without notice. Not responsible for errors or omissions. ©2020 Advanced Energy Industries, Inc. All rights reserved. Advanced Energy®, and AE® are U.S. trademarks of Advanced Energy Industries, Inc.