

POWER FOR 5G NETWORKS

PREMIER TECHNOLOGIES | PROVEN CAPABILITIES



PRECISION | POWER | PERFORMANCE



5G Network Power Supplies

Standard and Custom Solutions
to Power Wireless Networks

Your Global Partner for 5G Network Power Solutions

Advanced Energy's Artesyn product line delivers custom solutions and standard products to power wireless networks and has since the dawn of mobile communications. The very first cellular networks were powered by Artesyn telecom power supply units, rectifiers, and DC-DC modules.

With power conversion solutions installed in mobile networks throughout the world, Advanced Energy is the trusted power conversion supply partner of large network equipment providers and smaller innovators for radio access networks, edge networks, aggregation layer solutions, backhaul, and optical and core network equipment.

With the rollout of 5G, cellular networks require more small cells than previous generations. These small cell base-stations deliver enhanced mobile broadband, low latency, and reliable service to users.

Advanced Energy's fanless AC-DC solutions are ideal for remote radio heads. With one of the widest ranges of telecom DC-DC solutions, these solutions deliver the efficiency, density, reliability, and quality needed for the new small cell base-stations.

In addition, there's a trend towards the use of IT infrastructure such as cloud data centers and hyperscale cloud providers for both the edge and core needs of communication service providers. Advanced Energy's long history in the server, computing, and storage industry includes both standard products and custom solutions to optimize power usage from the rack to the chip.

Key criteria in selecting power conversion solutions for 5G infrastructure

- Reliability
- Efficiency
- Size
- Thermal Management
- Technical characteristics
 - EMI and noise
 - Surge suppression
 - Inrush limiting
 - Transient response
 - Overload protection



Telecom and Computing Power Solutions

Advanced Energy is a market leader in power conversion solutions for systems that use distributed power architectures (DPA), intermediate bus architectures (IBA), and 48 V direct conversion. With an exceptionally broad range of standard products spanning every aspect of this market sector, we offer power conversion solutions for most applications.

Our extensive range of bulk front end AC-DC and DC-input power supplies includes 1U, 2U, and 3U high rack-mounting modular power models with individual power ratings from 800 to 3000 W. In addition, 19 inch rack mounting shelf units are available for many front end power supplies to help users configure compact bulk power systems with very high output capabilities.

For power requirements outside of the range of standard products listed, contact Advanced Energy to discuss available modified and custom products.

KEY FEATURES

- Complete rack power solutions including shelves, distribution, controllers, backup and server power supplies
- High efficiency
- High reliability



Front End Power Supplies

Our bulk power front-ends offer Titanium or Platinum efficiency ratings with individual power ratings from 500 up to 3000 W. The range includes 1U, 2U, and 3U high rack-mounting modular power supplies as well as AC or DC-input variants.



Power Supply Shelves/Racks

At the shelf or rack level, we offer complete system power solutions from 1400 to 36,000 W. At 1U high and designed for 19 inch racks, these solutions can support multi-rack paralleling systems. We designed the shelves to maintain the thermal performance of the power supplies and simplify installation.



Back-up Power

Protect mission critical information when you need it, where you need it. Advanced Energy provides backup solutions to ensure that power is maintained whenever there is an AC power outage. Our design and manufacturing expertise provides solutions to meet your total backup power needs. These solutions are engineered to manage cost, battery run time and cycle life, and anticipate when it's time for periodic battery maintenance.



Power Distribution Units

Advanced Energy provides a wide range of power distribution solutions from simplistic to intelligently managed distributed network power. Whatever your power needs are, Advanced Energy can provide filtering, load balancing, metering, and monitoring and control solutions.

Conduction-cooled, Fanless Power Supplies

Advanced Energy’s Artesyn LCC series consists of fanless, fully-enclosed, IP64 rated AC-DC power supplies, ideal for use in demanding sealed box and outdoor applications such as in cellular towers and in ground equipment cabinets.

With IP64 protection against the ingress of dust and water, wide operating temperature range, and extensive protection against fault conditions, these products are ideal for 5G access network deployments.

While current models are rated at 250 and 600 W, future models will address higher power requirements. For maximum applications flexibility, the main output is adjustable and the 600 W models support active current sharing so that up to five units can be connected in parallel for high current applications. The LCC600 series also features a PMBus®-compliant I2C communication interface to facilitate remote set up and monitoring.

Customers can choose between two mounting and cooling orientations: conduction or convection. These power supplies incorporate a thermal baseplate and are capable of delivering full output power over a wide baseplate operating temperature range of -40 to 85°C.

While 5G networks aren’t medical applications, the fact that the LCC series has been tested and approved to extremely stringent medical safety standards is a testament to the build quality and reliability of this innovative series of power supplies.

Fans are one of the least reliable components in a power supply. The fanless LCC series matches well for high uptime and difficult to service equipment where fan failures can be costly.

A universal AC input enables them to be used almost anywhere in the world.

KEY FEATURES

- Fanless, conduction/convection cooled
- IP sealed variants
- High efficiency
- High power density
- High altitude operation, up to 5000 m
- Tight line and load regulations
- Full output power over -40 to 85°C baseplate operating temperature range

LCC250



LCC600 Series







Open Frame Power Supplies

Advanced Energy is a market leader in low to medium power AC-DC power supplies. These products provide outstanding performance, reliability, and cost-effectiveness. For these reasons, customers prefer to integrate them into 5G switches among other networking equipment. Similar to our conduction-cooled units, many of the open frame power supplies feature medical safety approvals, underlining the build quality and reliability.

Our range of low to medium power AC-DC power supplies extends from 25 to 650 W and offers an exceptionally wide variety of configuration options. Most of these power supplies are available with a choice of single or multiple isolated outputs with numerous different voltage combinations, and a considerable number also provide auxiliary outputs for powering fans and standby circuits.

All of our low to medium power AC-DC power supplies are high-efficiency switch-mode designs and feature a universal AC input, making them suitable for use almost anywhere in the world. Most models above 60 W offer harmonic current correction to meet the EN61000-3-2 standard. The majority of these power supplies are available in open-frame and enclosed configurations, with a choice of convection or fan-assisted cooling.

KEY FEATURES

- High efficiency
- High power density
- High altitude operation, up to 5000 m
- Tight line and load regulations
- Start up as low as -40°C

LPS360



CPS250



CNS650



DC-DC Modules

Advanced Energy offers industry standard telecom-grade DC-DC converters with output power capabilities from 35 to 800 W in form factors of sixteenth-, eighth-, quarter-, half-, and full-brick. In addition, our DC-DC telecom bricks are IEC62368 safety standard compliant.

These solutions also offer wide choices of voltages and a form factor for surface mount or through-hole terminations. The open frame designs are able to be fitted with an optional baseplate for enhanced thermal performance. Flat efficiencies of greater than 95% are essential for cellular networks and our products meet and exceed that.

Included in our portfolio are isolated, digitally-controlled power solutions in quarter- and eighth-brick form factors (ADO, ADQ, and BDQ series) and point-of-load (POL) modules (LGA series).

Our 48V direct conversion DC-DC modules follow the industry-standard definitions of the Power Stamp Alliance.

Digital power management capabilities provide integration of more sophisticated sequencing processes in complex high-current multiphase applications with many power rails. Designers can choose a design for the most effective sequence for powering up and powering down the various rails in the system.

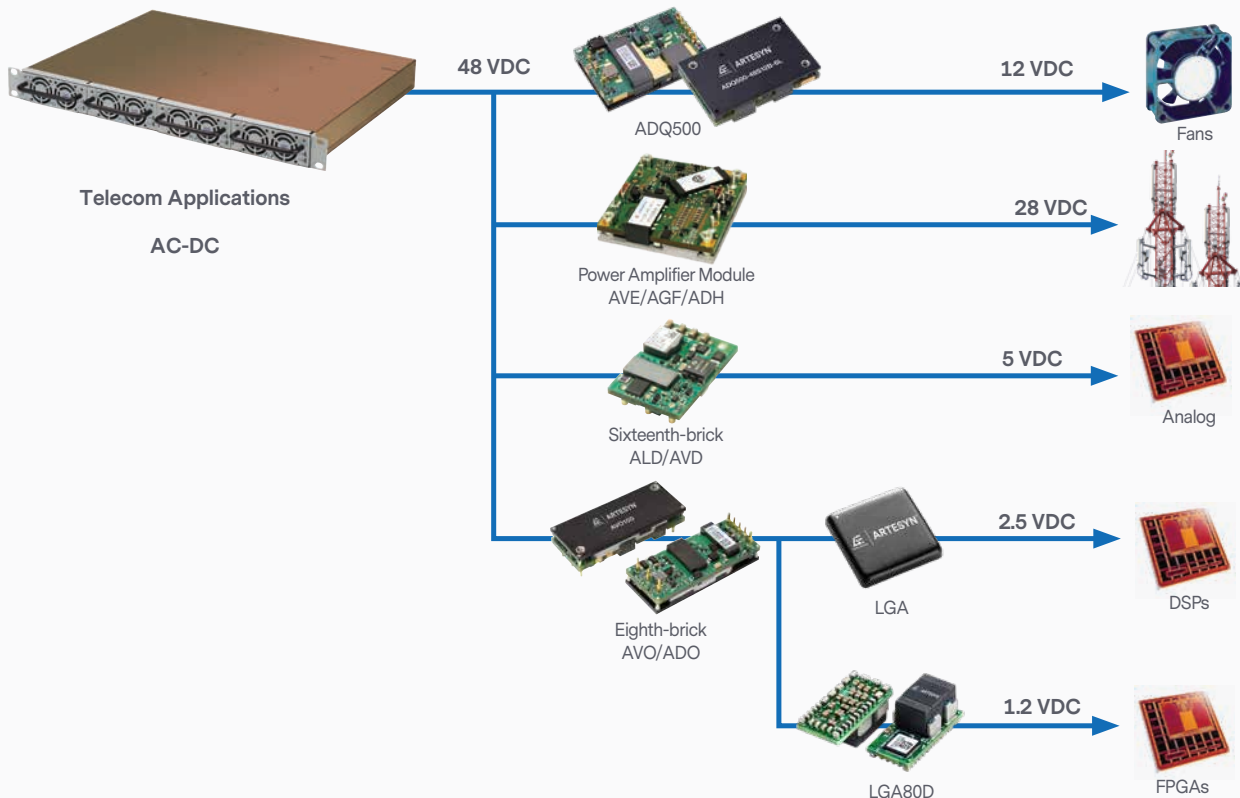

KEY FEATURES

- Isolated telecom bricks 35 to 800 W
- Non-isolated POL modules
- 48 V direct conversion modules
- High efficiency
- High power density
- Digital control options
- 50 to 118% V-adjust for RFPA

Power Supplies for Power Amplifiers

Highly efficient DC-DC converters in the power amplifier (PA) power supply contribute to improving the efficiency of the overall system. Many of these telecom bricks have fold back overload protection that will not switch off completely, so it will not lose subscriber connections in the event of an overload condition or a fast transient.

The isolated DC-DC converters offer the low noise, regulated DC supply that RF power amplifiers require and Advanced Energy offers modules designed for either LDMOS or GaN RF PAs.

Effective thermal management in the design is paramount, especially when it comes to Remote Radio Heads (RRH). Advanced Energy's DC-DC converters have been designed to be contact-cooled inside an IP-sealed enclosure. Our Artesyn RF PA bricks have a baseplate which is optimized for thermal bonding to the host enclosure. The full power rating of the unit will be available as long as the baseplate remains less than 100°C.

Since enclosure height is another essential factor in small cells for 5G, slim/compact power footprint is essential. Advanced Energy's Artesyn DC-DC modules offer 12 mm height in IP-sealed cases and can handle temperatures higher than 85°C on the baseplates at full load when in the sun.

Also, our bricks have a wide range of output voltage adjustment, from 50 to 118%, aiding the PA efficiency and reducing the need for cooling. PA voltage adjustment, to follow changes in the PA envelope, can be achieved with the adjustment of the power supply voltage output voltage trim pin.

- Telecom Input voltage; 36-75Vin
- Output voltages
 - 28V nominal for LDMos RF transistors
 - 50V Nominal for GaN RF transistors
- Standard form factors
 - Full bricks
 - ½ bricks
 - ¼ bricks
 - ⅛ bricks
- Optimized output current limiting function for RFPA applications
- Efficiencies up to 96%
- IEC62368 approved
- 100% Power at 105°C baseplate
- High reliability

ADH700

700 W ½ brick



AGF800

800 W Full brick



AGQ500

500 W ¼ brick



AVO250

250 W ⅛ brick



48V input converters

Advanced Energy produces an extensive range of Artesyn-branded industry-standard brick type isolated DC-DC converters for telecommunications applications. Models with sixteenth-, eighth-, quarter-, and half-brick form factors with available power outputs from 35 to 600W cover virtually every requirement.

All converters offer a wide choice of voltage variants (3v3, 5 V, and 12 V available) and most include options for surface-mount or through-hole terminations. With the open-frame design, these converters can be fitted with an optional baseplate for enhanced thermal performance.

1/16 Bricks

AVD50B-48SXX

36 to 75 V_{in} 50 W

AVD85B-48SXX

36 to 75 V_{in} 85 W

AVD120-48SXX

36 to 75 V_{in} 120 W

AVD200-48SXX

36 to 75 V_{in} 200 W

AVD85B

Baseplate version



AVD120

Open-frame, PHT version



AVD200



1/8 Bricks

AVO120-48SXX

36 to 75 V_{in} 120 W

AVO200-48SXX

36 to 75 V_{in} 200 W

ADO300-48SXX

36 to 75 V_{in} 300 W

AVO100/120



AVO200



ADO300



1/4 Bricks

ADQ500-48SXX

36 to 75 V_{in} 500 W

ADQ600B-48SXX

36 to 75 V_{in} 600 W

ADQ700-48SXX

40 to 60 V_{in} 700 W

ADQ800-48SXX

40 to 60 V_{in} 800 W

BDQ1300-48SXX

40 to 60 V_{in} 1300 W

ADQ500



ADQ600



ADQ700



ADQ800



BDQ1300



Direct Conversion PSA-compliant Modules

Artesyn ADC100MXX
40 to 60 V_{in} 100Amp(pk) 1.8V

Artesyn ADC100SXX
40 to s60 V_{in} 100Amp(pk) 1.8V

**Artesyn ADC100C
Controller Stamp**
40 to s60 V_{in} 5 V VDD + 5 V VCC

ADC100M



ADC100S



The Artesyn ADC100 series converters follow the industry's first standardized footprint for single-stage, direct conversion modules - termed "Power Stamps". Artesyn was one of the founding members of the Power Stamp Alliance which defined the standard footprints.

The Power Stamp Alliance shares selected information to assure a standard form factor, mechanical, feature set and functional compatibility to provide a multiple sourced, standard power supply solution to applications where the demand is for power conversion from a nominal 48 V input to an output of low voltage at high current with on-board isolated and

non-isolated DC-DC power converters with the added benefit of up to a 40% PCB real-estate reduction compared to a 2-stage (48V:12V then 12V:LV) design approach.

The PSA solution provides a scalable solution that can be used in tandem with existing power conversion devices in order to allow the practical realization of an application.

The product definition will be at the level of both footprint and function only in order to create a standardized solution. This is intended to allow practical multiple sourcing and qualification of the products.

Controller stamp and satellites

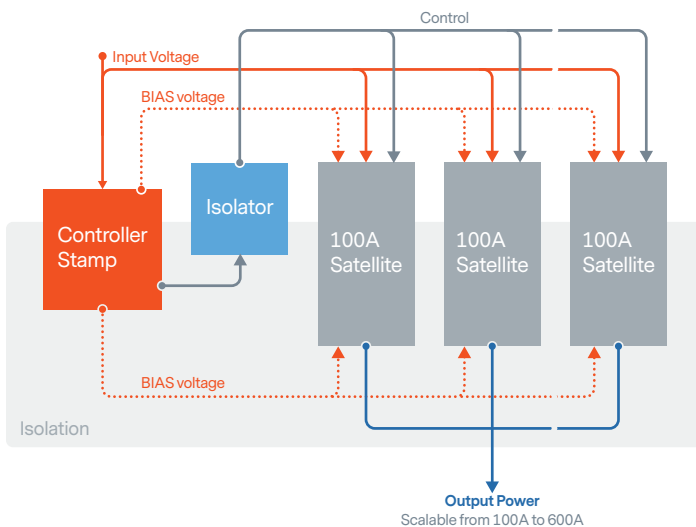

100A main stamp and satellites

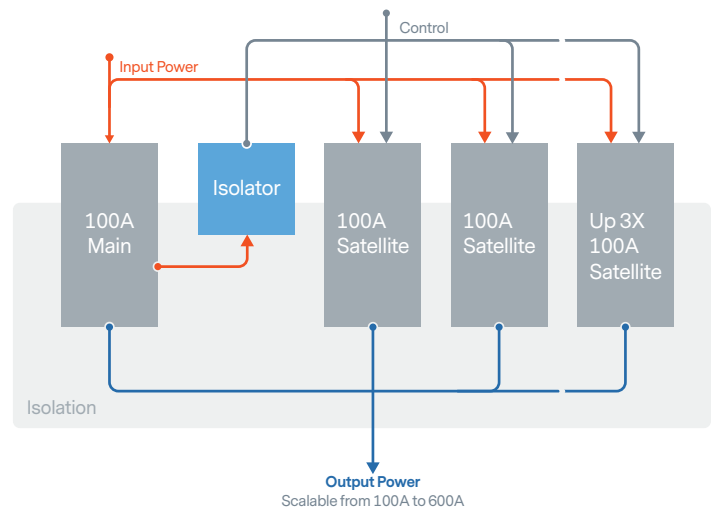

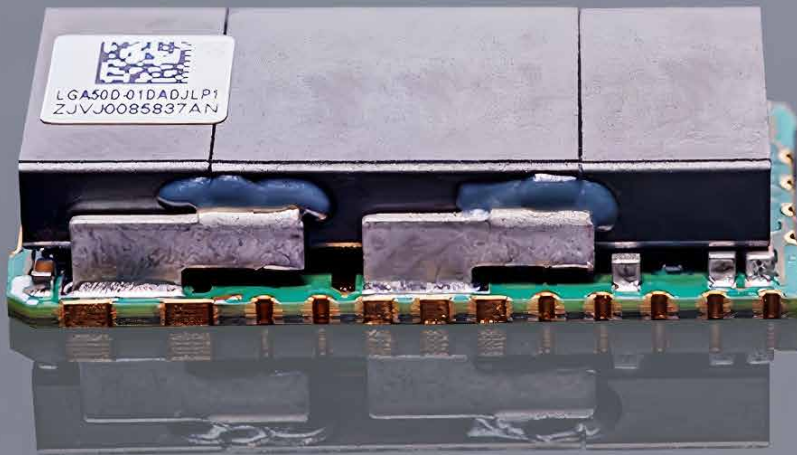

Non-Isolated DC-DC Modules

The digital interface versions of the units allow communication to the converter via the PMbus[®] command protocol with control and monitoring functions for voltage, current, temperature, and the setting and reporting of fault conditions. Standard analog control features include output voltage trim, output voltage sense compensation, and remote enable functions.

With a footprint of 25.4 mm (1 in) by 12.5 mm (0.5 in), the Artesyn LGA80D and LGA50D modules represent some of the highest density current ratings available in the industry. These innovative units offer two independent outputs, which can either be configured as a single output or two completely independently controlled outputs. The Artesyn LGA80D can be configured as two 40 A outputs or a single 80 A output, whereas the Artesyn LGA50D can be configured as two 25 A outputs or a single 50 A output. It is also possible to generate a higher current rated rail connect units in parallel. For example, by connecting four LGA80D units in parallel up to 320 A can be supplied as a single power rail.

The Artesyn LGA series share the same control functionality and flexibility. The wide trim feature (0.6 to 5.2 V) makes them suitable for use with a broad range of semiconductor devices. Both analog and digital control functions are enabled on this unit, which means the units can be either controlled with a resistor or alternatively, be fully controlled and monitored by using the universally accepted industry standard PMbus[®] digital interface. For designers using this category of product, critical parameters for consideration are efficiency and derating. The Artesyn LGA series offers class-leading efficiencies with very little or no derating factor applied to the power-limit of the LGA80D at 200 W maximum (two 100 W output channels) and LGA50D at 100 W maximum (two 50 W channels).



Artesyn LGA50D Mounting Variants

- 12 V_{in}
- 2 channels 25 A output
- Output voltage adjustable 0.6 to 5.2 V
- PMbus® control

Single unit Dual O/P configuration

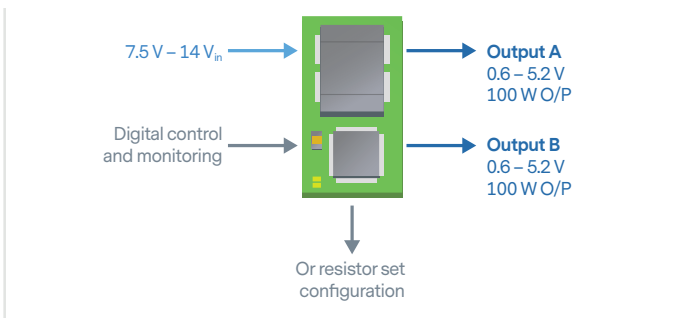

Single unit Single O/P configuration

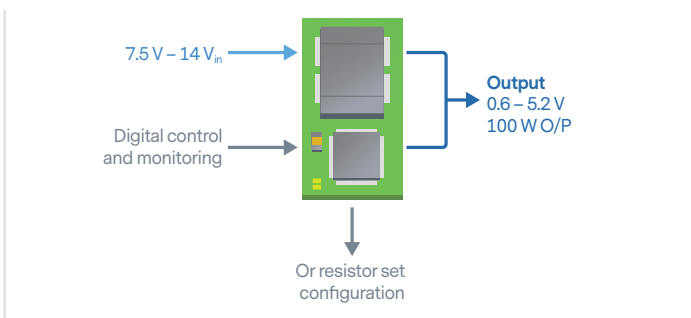

Artesyn LGA80D Mounting Variants

- 12 V_{in}
- 2 channels 40 A output
- Output voltage adjustable 0.6 to 5.2 V
- PMbus® control

Up to four stacked units in Single O/P configuration

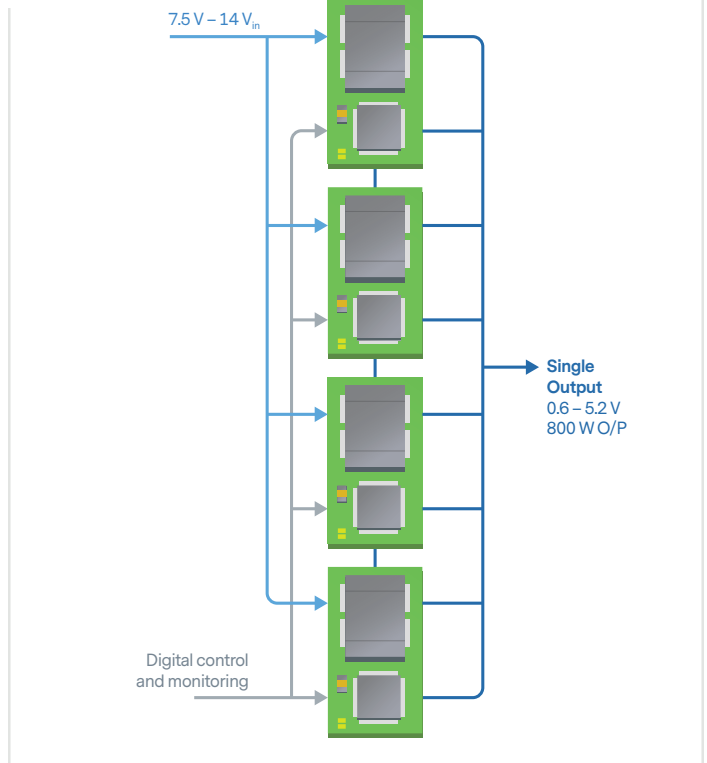



For international contact information,
visit advancedenergy.com

powersales@aei.com
+1 888 412 7832

ABOUT ADVANCED ENERGY

Advanced Energy (AE) has devoted more than three decades to perfecting power for its global customers. We design and manufacture highly engineered, precision power conversion, measurement and control solutions for mission-critical applications and processes.

Our products enable customer innovation in complex applications for a wide range of industries including semiconductor equipment, industrial, manufacturing, telecommunications, data center computing, and medical. With deep applications know-how and responsive service and support across the globe, we build collaborative partnerships to meet rapid technological developments, propel growth for our customers, and innovate the future of power.

PRECISION | POWER | PERFORMANCE

Specifications are subject to change without notice. Not responsible for errors or omissions. ©2021 Advanced Energy Industries, Inc. All rights reserved. Advanced Energy® and AE® are U.S. trademarks of Advanced Energy Industries, Inc.