

ARTESYN

ERM 100W SERIES

DC/DC converter



PRODUCT DESCRIPTION

Advanced Energy's Artesyn ERM100 series is a new generation of high performance, isolated dc-dc converter modules. The product offers 100W in a small, fully encapsulated package. The input voltage ranges comply with European railway standard EN50155. Reinforced insulation and high EMC immunity qualifies these converters also for many demanding applications in railway and other transportation systems.

Advanced circuit topology provides a very high efficiency up to 91.5% which allows ambient temperatures range up to +85°C with derating.

SPECIAL FEATURES

- Small 58.4 x 37.3 x17 mm package
- 36 to 160 Vdc wide-range input
- High efficiency up to 91.5%
- Base-plate optimized for contact cooling or heatsink mounting
- No minimum load requirement
- Fixed switching frequency
- High reliability
- RoHS 3.0 compliant
- UL94 V-0 materials
- DOSA quarter-brick footprint compliant
- Heatsink version available
- Operating temperature -40 to +85°C (subject to derating)
- EN 61373; Vibration and thermal shock
- 3 years warranty

SAFETY

- TUV EN 62368 EN 50155
- UL UL 62368-1
- TUV CB IEC 62368-1 IEC 60571
- CE and UKCA Mark

TYPICAL APPLICATIONS

- Railway

AT A GLANCE

Total Power

100 Watts

Input Voltage

36 to 160 Vdc

of Outputs

Single



MODEL NUMBERS

Model	Input Voltage	Output Voltage	Minimum Load	Maximum Load	Efficiency
ERM20A100	36-160Vdc	5Vdc	0A	20A	91.5%
ERM08B100	36-160Vdc	12Vdc	0A	8.4A	91%
ERM06C100	36-160Vdc	15Vdc	0A	6.7A	90.5%
ERM04H100	36-160Vdc	24Vdc	0A	4.2A	89%
ERM01U100	36-160Vdc	54Vdc	0A	1.85A	89%

Options

Negative enable (N)

Heatsink (-HS)

ELECTRICAL SPECIFICATIONS

Absolute Maximum Ratings

Stress in excess of those listed in the “Absolute Maximum Ratings” may cause permanent damage to the power supply. These are stress ratings only and functional operation of the unit is not implied at these or any other conditions above those given in the operational sections of this TRN. Exposure to any absolute maximum rated condition for extended periods may adversely affect the power supply’s reliability.

Table 1. Absolute Maximum Ratings						
Parameter	Model	Symbol	Min	Typ	Max	Unit
Input Voltage Non-operating - 100mS	All models	$V_{IN,DC}$	-0.7	-	170	Vdc
Maximum Output Power	All models	$P_{O,max}$	-	-	100	W
Isolation Resistance 500Vdc	All models		10	-	-	Gohm
I/O Isolation Capacitance 100KHz, 1V	All models		-	-	1500	pF
Isolation Voltage						
Input to output	All models		2000	-	-	Vac
Input to case	All models		1500	-	-	Vac
Output to case	All models		500	-	-	Vac
Operating Ambient Temperature (With derating, refer to derating curve)	All models	T_A	-40	-	+85	°C
Operating Base-plate Temperature Range	All models		-40	-	+105	°C
Storage Temperature	All models	T_{STG}	-50	-	+125	°C
Fire protection test	Compliance to EN45545-2					
Humidity (non-condensing)	All models		5	-	95	%
MTBF (MIL-HDBK-217F@25°C, Full load, Groun Benign)	All models		605,102	-	-	Hours

ELECTRICAL SPECIFICATIONS

Input Specifications

Table 2. Input Specifications						
Parameter	Conditions	Symbol	Min	Typ	Max	Unit
Operating Input Voltage, DC	All	$V_{IN,DC}$	36	110	160	Vdc
Turn-on Voltage Threshold	All	$V_{IN,ON}$	-	-	36	Vdc
Turn-off Voltage Threshold	All	$V_{IN,OFF}$	-	35	-	Vdc
Maximum Input Current	ERM20A100(N)-(HS)	$V_{IN,DC}=V_{IN,nom}$ $I_O=I_{O,max}$	-	993.5	-	mA
	ERM08B100(N)-(HS)		-	1007	-	
	ERM06C100(N)-(HS)		-	1009	-	
	ERM04H100(N)-(HS)		-	1029	-	
	ERM01U100(N)-(HS)		-	1020	-	
No Load Input Current	$V_{IN,DC}=V_{IN,nom}$	I_{IN,no_load}	-	6	-	mA
Efficiency @Max. Load	ERM20A100(N)-(HS)	$V_{IN,DC}=V_{IN,nom}$ $I_O=I_{O,max}, T_A=25^{\circ}C$	-	91.5	-	%
	ERM08B100(N)-(HS)		-	91	-	
	ERM06C100(N)-(HS)		-	90.5	-	
	ERM04H100(N)-(HS)		-	89	-	
	ERM01U100(N)-(HS)		-	89	-	
Start Up Time			-	50	-	mS
Internal Filter Type	Internal Capacitor					

ELECTRICAL SPECIFICATIONS

Output Specifications

Table 3. Output Specifications							
Parameter		Conditions	Symbol	Min	Typ	Max	Unit
Factory Set Voltage		$V_{IN,DC}=V_{IN,nom}$ $I_O=I_{O,max}$, $T_A=25^{\circ}C$	V_O	-1	-	1	%
Line Regulation		$V_{IN,DC}=V_{IN,min}$ to $V_{IN,max}$	V_O	-0.2	-	0.2	%
Load Regulation		$I_O=I_{O,min}$ to $I_{O,max}$	V_O	-0.3	-	0.3	%
Output Current	ERM20A100(N)-(HS)	Convection Cooling	I_O	-	-	20	A
	ERM08B100(N)-(HS)			-	-	8.4	
	ERM06C100(N)-(HS)			-	-	6.7	
	ERM04H100(N)-(HS)			-	-	4.2	
	ERM01U100(N)-(HS)			-	-	1.85	
Load Capacitance	ERM20A100(N)-(HS)	Start up	C_O	-	-	34000	uF
	ERM08B100(N)-(HS)			-	-	5830	
	ERM06C100(N)-(HS)			-	-	3670	
	ERM04H100(N)-(HS)			-	-	1460	
	ERM01U100(N)-(HS)			-	-	380	
Output Voltage Trim Range	Other Models	All	V_O	-10	-	10	%
	54V Output	All	V_O	-15	-	5	%
Switching Frequency	Other Models	All	f_{SW}	-	214	-	KHz
	54V Output	All	f_{SW}	-	173	-	KHz
Temperature Coefficient		All	$\%V_O$	-	-	0.02	$\%/^{\circ}C$
Output Over Current Protection		All	$\%I_{O,max}$	-	130	-	%
Output Temperature Protection (Baseplate)		All	$T_{Baseplate}$	-	110	-	$^{\circ}C$
Output Short Circuit Protection		All	Hiccup Mode 0.3Hz type, Automatic Recovery				
Output Ripple, pk-pk	ERM20A100(N)-(HS)	20MHz bandwidth	V_O	-	100	-	mV_{PK-PK}
	ERM08B100(N)-(HS)				150		
	ERM06C100(N)-(HS)				150		
	ERM04H100(N)-(HS)				200		
	ERM01U100(N)-(HS)				300		
Output Over Voltage Protection	ERM20A100(N)-(HS)	All	V_O	-	6.2	-	Vdc
	ERM08B100(N)-(HS)			-	15	-	
	ERM06C100(N)-(HS)			-	18	-	
	ERM04H100(N)-(HS)			-	30	-	
	ERM01U100(N)-(HS)			-	66	-	
V_O Dynamic Response	Peak Deviation	25% load change	$\pm\%V_O$	-	3	5	%
	Recovery Time		T_s	-	250	-	uSec

ELECTRICAL SPECIFICATIONS

ERM20A100 Performance Curves

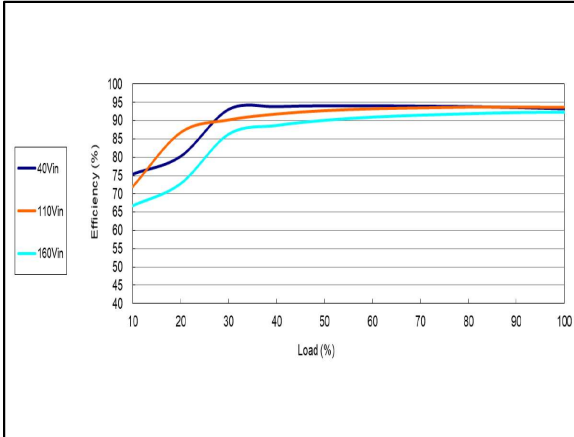

Figure 1: ERM20A100 Efficiency Versus Output Current Curve
 Vin = 110Vdc Load: Io = 0 to 20A

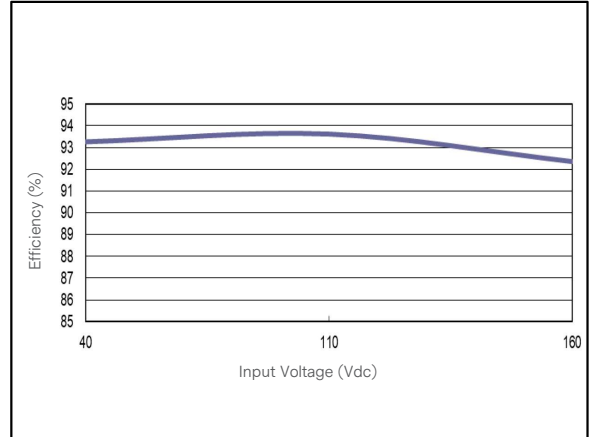

Figure 2: ERM20A100 Efficiency Versus Input Voltage Curve
 Vin = 40 to 160Vdc Load: Io = 20A

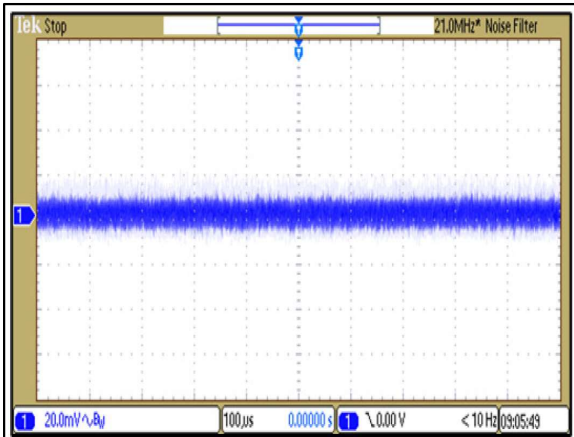

Figure 3: ERM20A100 Typical Output Ripple and Noise.
 Vin = 110Vdc Load: Io = 20A
 Ch 1: Vo

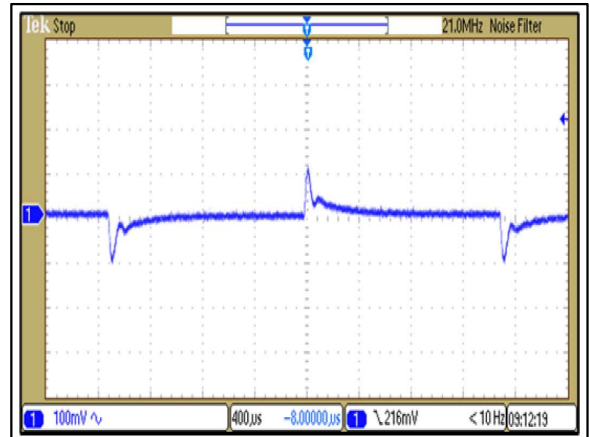

Figure 4: ERM20A100 Transient Response
 Vin = 110Vdc Load: Io = 100% to 75% load change
 Ch 1: Vo

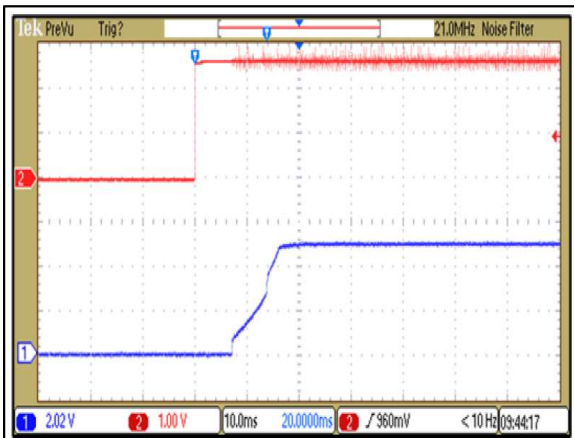

Figure 5: ERM20A100 Output Voltage Startup Characteristic by On/Off
 Vin = 110Vdc Load: Io = 20A
 Ch 1: Remote On/Off Ch 2: Vo

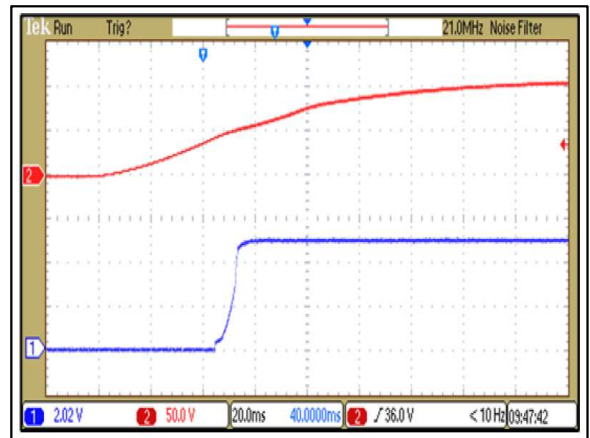

Figure 6: ERM20A100 Output Voltage Startup Characteristic by Vin
 Vin = 110Vdc Load: Io = 20A
 Ch 1: Vin Ch 2: Vout

ELECTRICAL SPECIFICATIONS

ERM20A100 Performance Curves

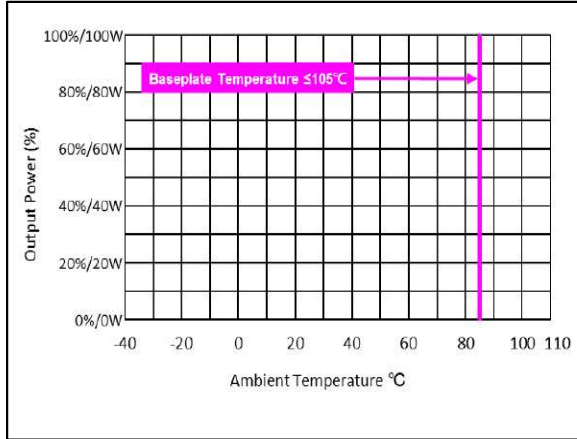

Figure 7: ERM20A100 Derating Curve without Heatsink
 Vin = 110Vdc Load: Io = 0 to 20A

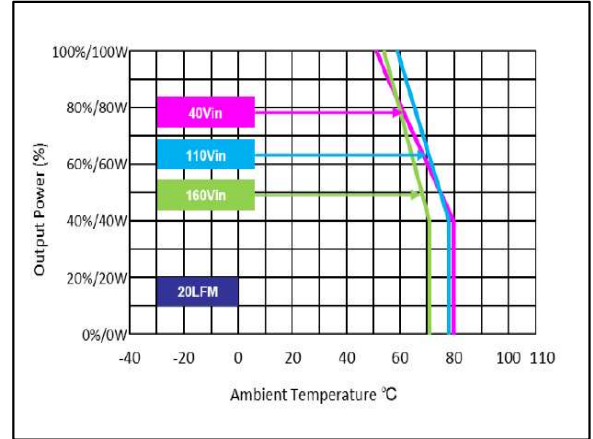

Figure 8: ERM20A100 Derating Curve with HS5 Heatsink
 Vin = 40 to 160Vdc Load: Io = 0 to 20A

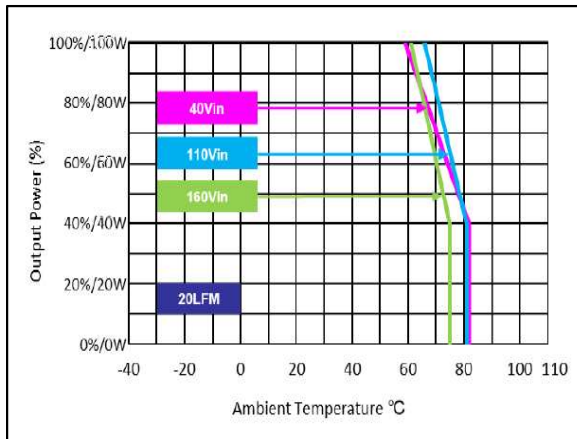

Figure 9: ERM20A100 Derating Curve with HS6 Heatsink
 Vin = 40 to 160Vdc Load: Io = 0 to 20A

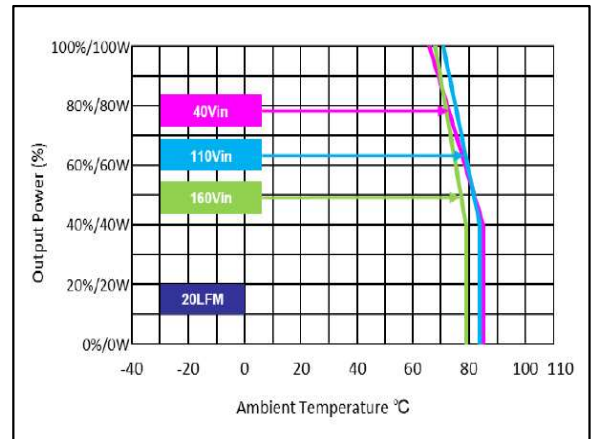

Figure 10: ERM20A100 Derating Curve with HS7 Heatsink
 Vin = 40 to 160Vdc Load: Io = 0 to 20A

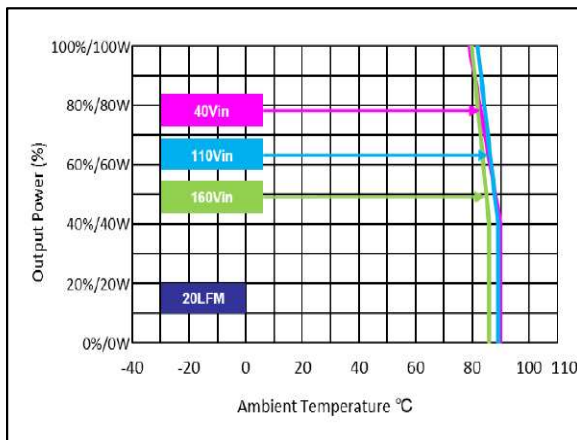

Figure 11: ERM20A100 Derating Curve with 2U iron back-plate (Dimension 241X89X1.6mm)
 Vin = 40 to 160Vdc Load: Io = 0 to 20A

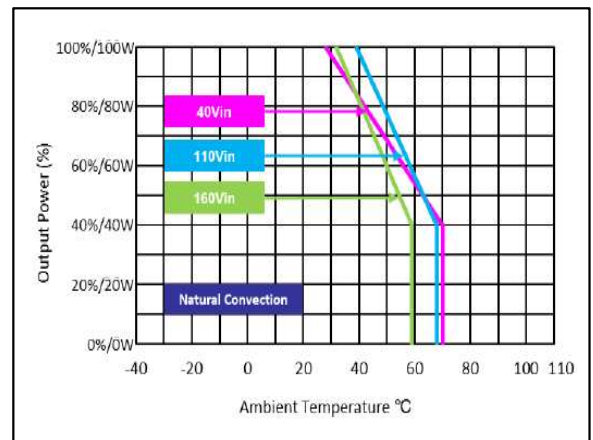

Figure 12: ERM20A100 Derating Curve with HS5 Heatsink
 Vin = 40 to 160Vdc Load: Io = 0 to 20A

ELECTRICAL SPECIFICATIONS

ERM20A100 Performance Curves

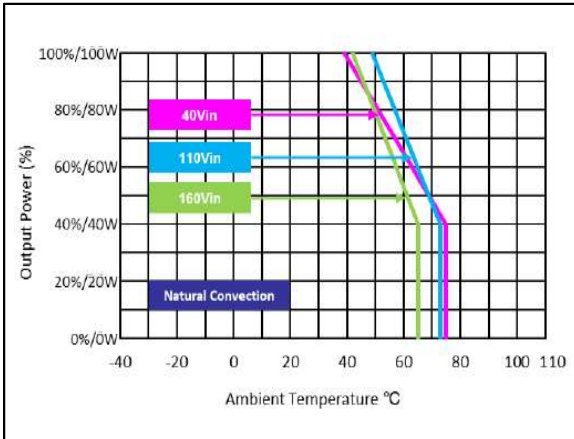

Figure 13: ERM20A100 Derating Curve with HS6 Heatsink
 Vin = 40 to 160Vdc Load: Io = 0 to 20A

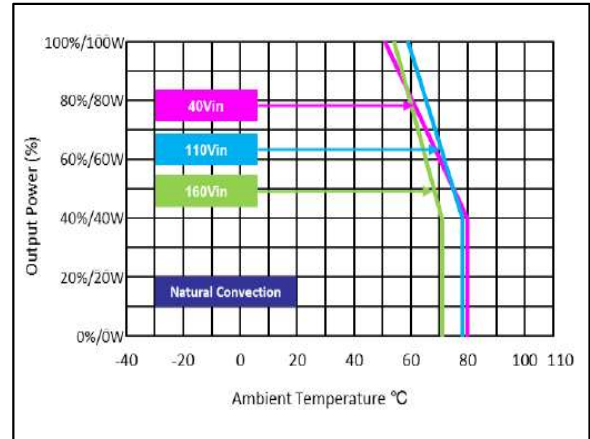

Figure 14: ERM20A100 Derating Curve with HS7 Heatsink
 Vin = 40 to 160Vdc Load: Io = 0 to 20A

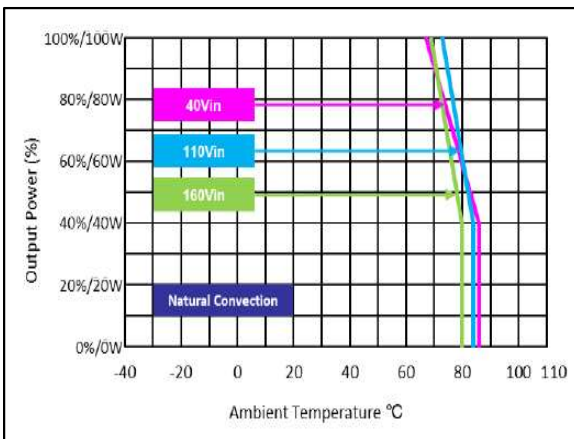

Figure 15: ERM20A100 Derating Curve with with 2U iron back-plate
 (Dimension 241X89X1.6mm)
 Vin = 40 to 160Vdc Load: Io = 0 to 20A

ELECTRICAL SPECIFICATIONS

ERM08B100 Performance Curves

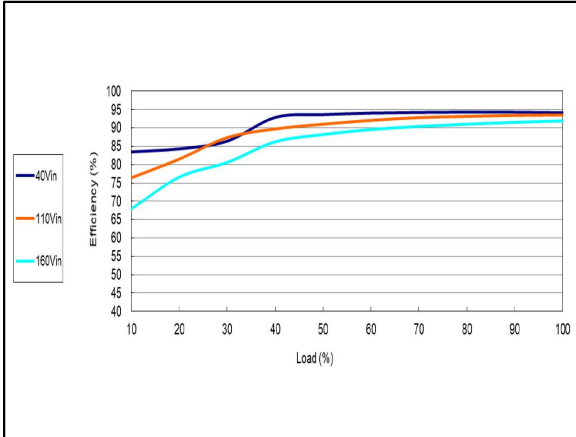

Figure 16: ERM08B100 Efficiency Versus Output Current Curve
 Vin = 110Vdc Load: Io = 0 to 8.4A

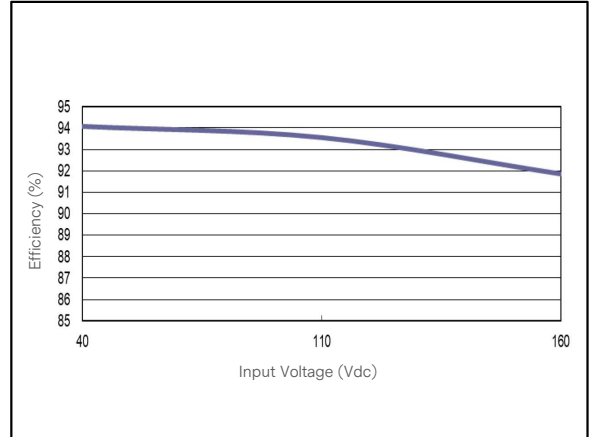

Figure 17: ERM08B100 Efficiency Versus Input Voltage Curve
 Vin = 40 to 160Vdc Load: Io = 8.4A

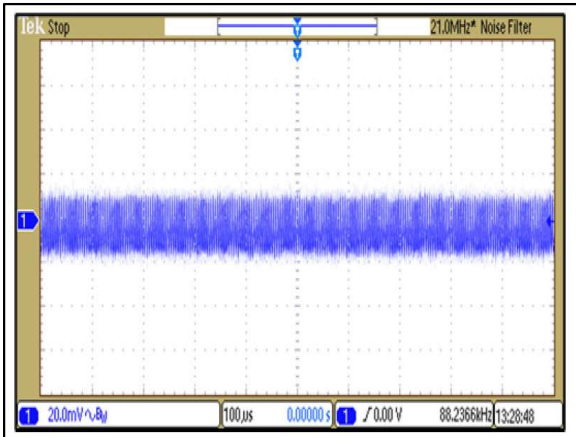

Figure 18: ERM08B100 Typical Output Ripple and Noise.
 Vin = 110Vdc Load: Io = 8.4A
 Ch 1: Vo

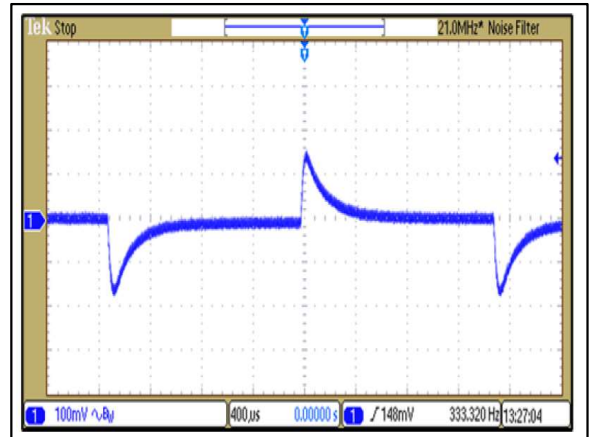

Figure 19: ERM08B100 Transient Response
 Vin = 110Vdc Load: Io = 100% to 75% load change
 Ch 1: Vo

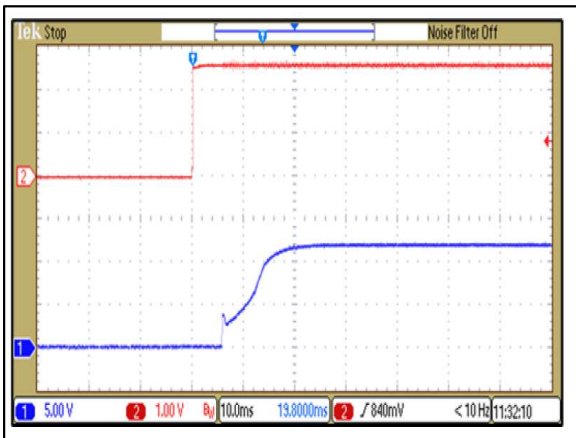

Figure 20: ERM08B100 Output Voltage Startup Characteristic by On/Off
 Vin = 110Vdc Load: Io = 8.4A
 Ch 1: Remote On/Off Ch 2: Vo

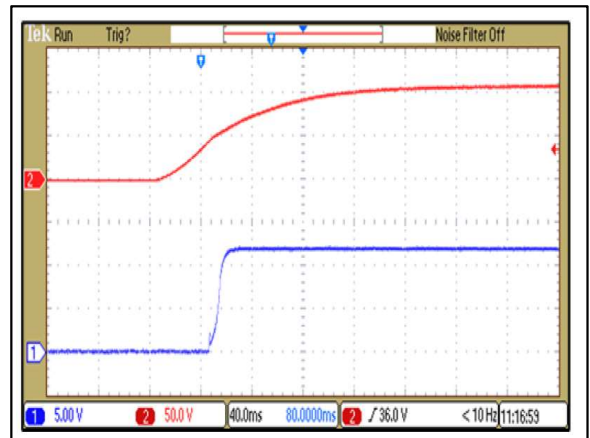

Figure 21: ERM08B100 Output Voltage Startup Characteristic by Vin
 Vin = 110Vdc Load: Io = 8.4A
 Ch 1: Vin Ch 2: Vo

ELECTRICAL SPECIFICATIONS

ERM08B100 Performance Curves

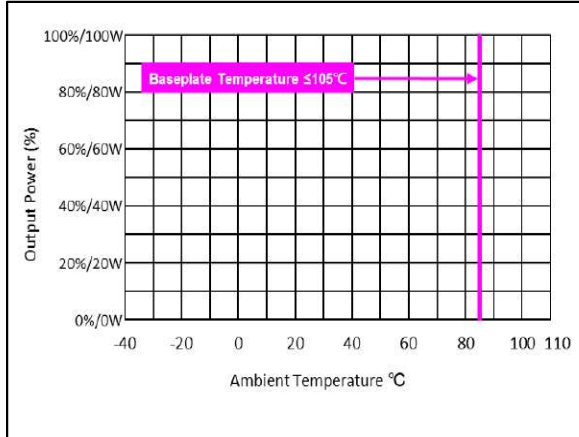

Figure 22: ERM08B100 Derating Curve without Heatsink
 Vin = 110Vdc Load: Io = 0 to 8.4A

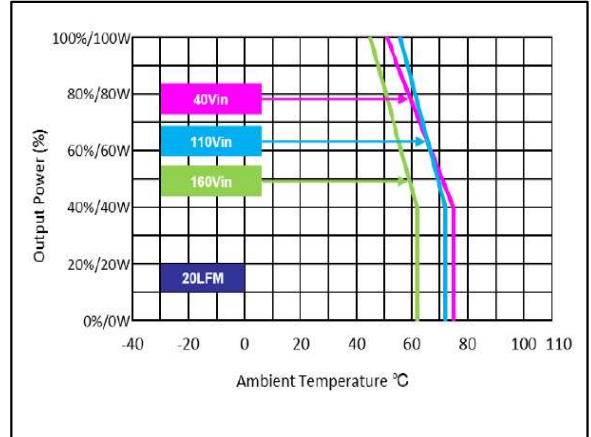

Figure 23: ERM08B100 Derating Curve with HS5 Heatsink
 Vin = 40 to 160Vdc Load: Io = 0 to 8.4A

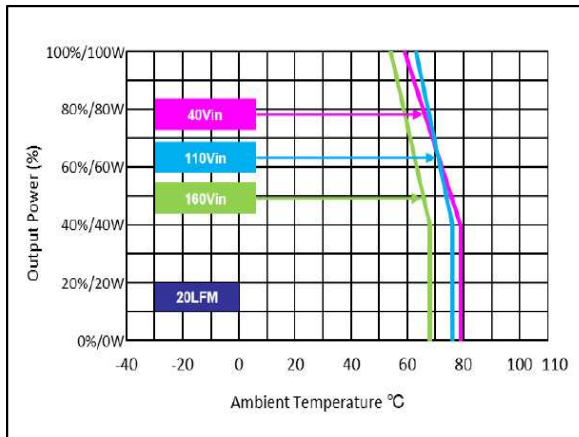

Figure 24: ERM08B100 Derating Curve with HS6 Heatsink
 Vin = 40 to 160Vdc Load: Io = 0 to 8.4A

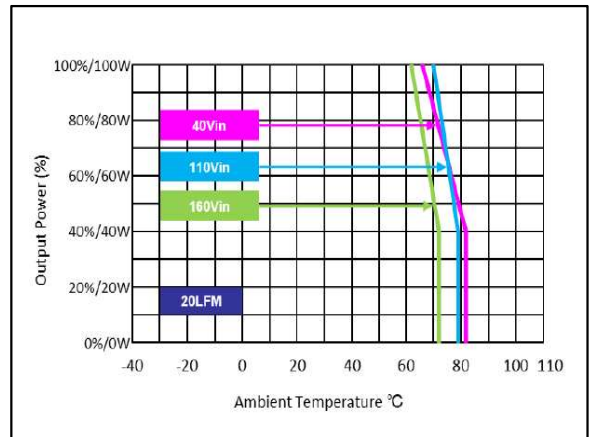

Figure 25: ERM08B100 Derating Curve with HS7 Heatsink
 Vin = 40 to 160Vdc Load: Io = 0 to 8.4A

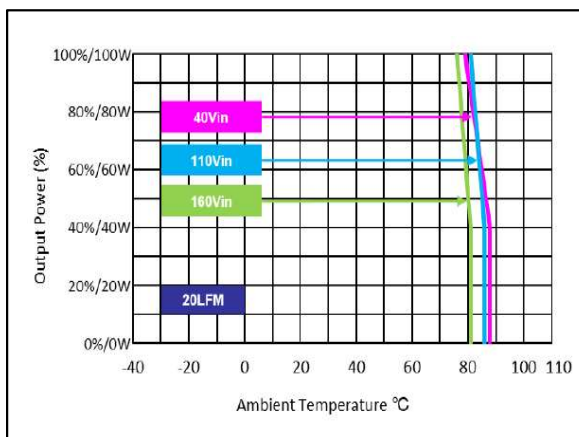

Figure 26: ERM08B100 Derating Curve with 2U iron back-plate
 (Dimension 241X89X1.6mm)
 Vin = 40 to 160Vdc Load: Io = 0 to 8.4A

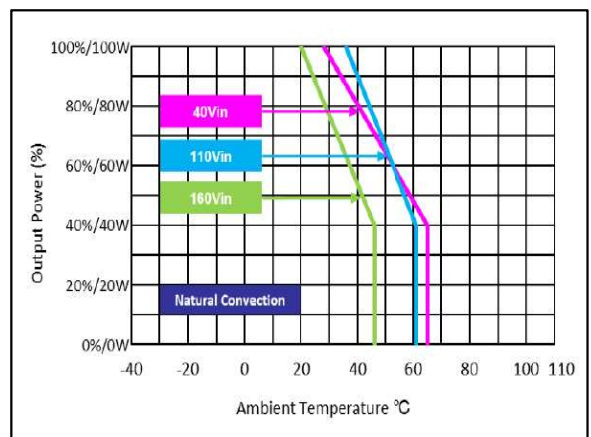

Figure 27: ERM08B100 Derating Curve with HS5 Heatsink
 Vin = 40 to 160Vdc Load: Io = 0 to 8.4A

ELECTRICAL SPECIFICATIONS

ERM08B100 Performance Curves

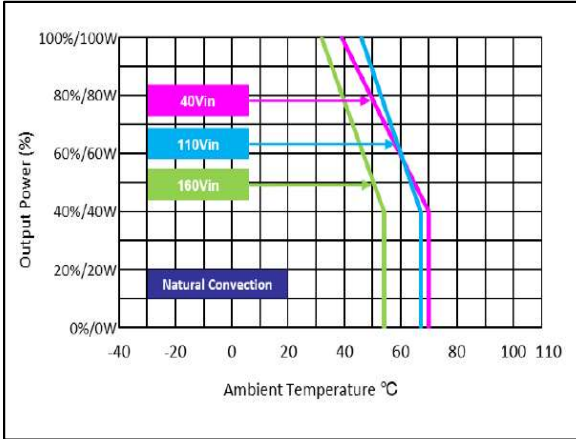

Figure 28: ERM08B100 Derating Curve with HS6 Heatsink
 Vin = 40 to 160Vdc Load: Io = 0 to 8.4A

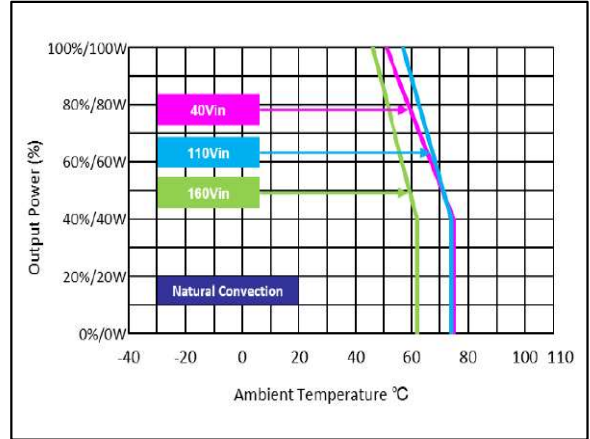

Figure 29: ERM08B100 Derating Curve with HS7 Heatsink
 Vin = 40 to 160Vdc Load: Io = 0 to 8.4A

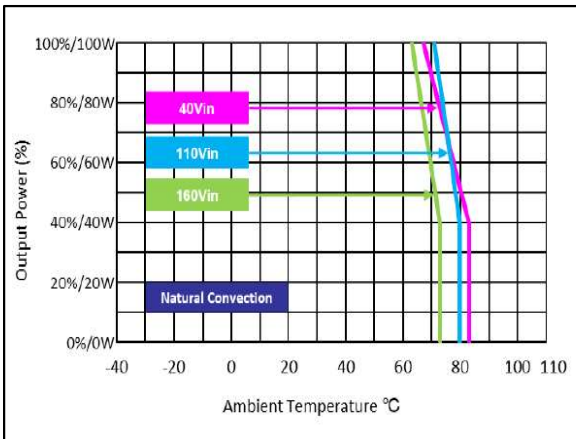

Figure 30: ERM08B100 Derating Curve with 2U iron back-plate
 (Dimension 241X89X1.6mm)
 Vin = 40 to 160Vdc Load: Io = 0 to 8.4A

ELECTRICAL SPECIFICATIONS

ERM06C100 Performance Curves

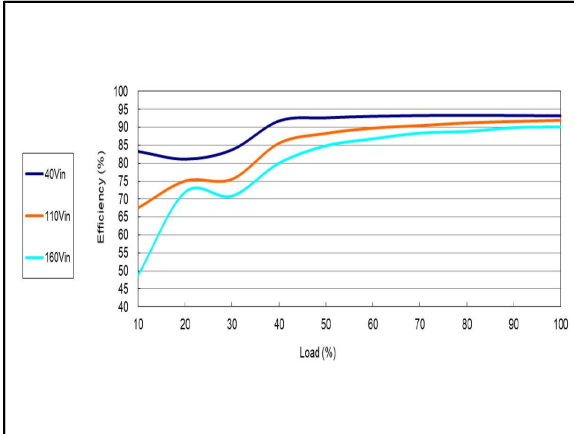

Figure 31: ERM06C100 Efficiency Versus Output Current Curve
 Vin = 110Vdc Load: Io = 0 to 6.7A

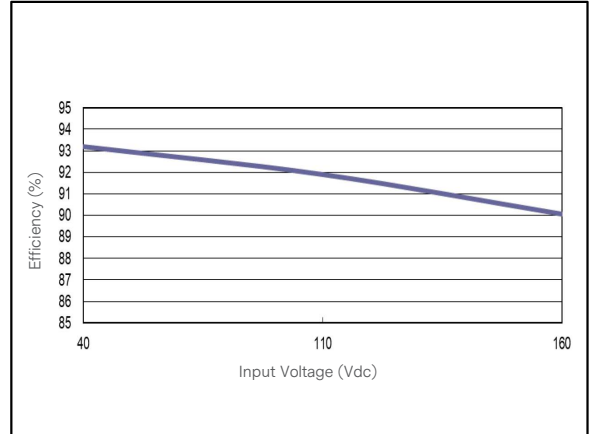

Figure 32: ERM06C100 Efficiency Versus Input Voltage Curve
 Vin = 40 to 160Vdc Load: Io = 6.7A

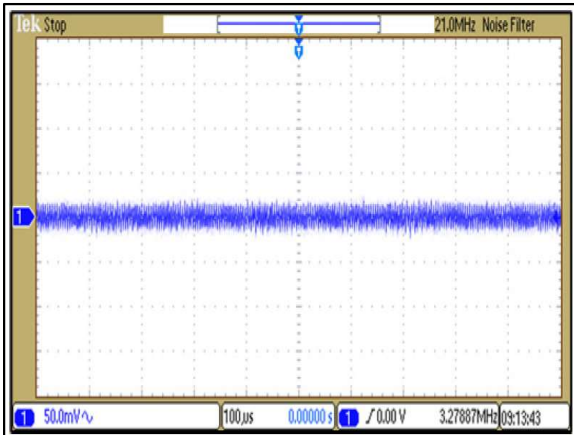

Figure 33: ERM06C100 Typical Output Ripple and Noise.
 Vin = 110Vdc Load: Io = 6.7A
 Ch 1: Vo

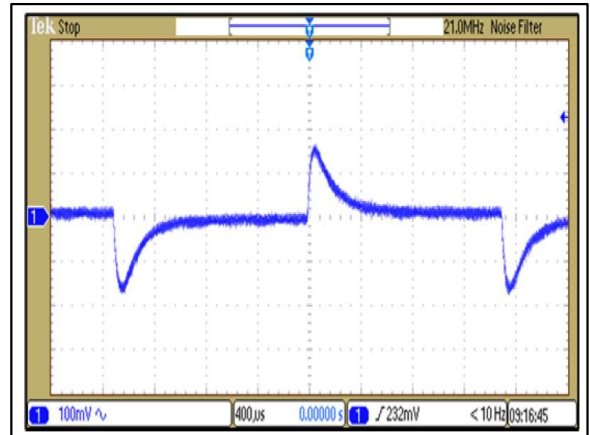

Figure 34: ERM06C100 Transient Response
 Vin = 110Vdc Load: Io = 100% to 75% load change
 Ch 1: Vo

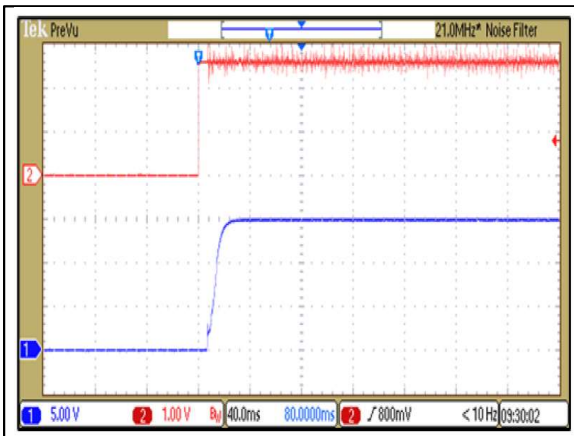

Figure 35: ERM06C100 Output Voltage Startup Characteristic by On/Off
 Vin = 110Vdc Load: Io = 6.7A
 Ch 1: Remote On/Off Ch 2: Vo



Figure 36: ERM06C100 Output Voltage Startup Characteristic by Vin
 Vin = 110Vdc Load: Io = 6.7A
 Ch 1: Vin Ch 2: Vo

ELECTRICAL SPECIFICATIONS

ERM06C100 Performance Curves

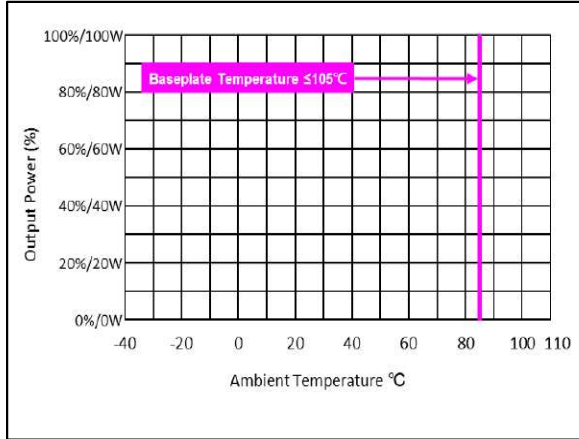

Figure 37: ERM06C100 Derating Curve without Heatsink
 Vin = 110Vdc Load: Io = 0 to 6.7A

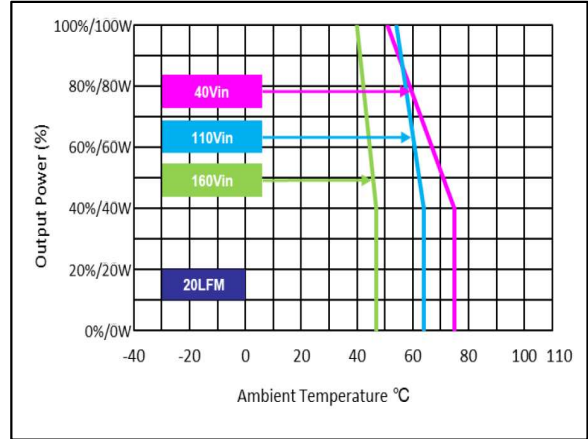

Figure 38: ERM06C100 Derating Curve with HS5 Heatsink
 Vin = 40 to 160Vdc Load: Io = 0 to 6.7A

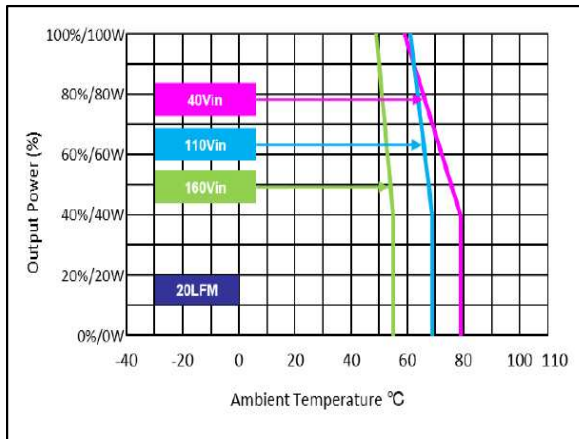

Figure 39: ERM06C100 Derating Curve with HS6 Heatsink
 Vin = 40 to 160Vdc Load: Io = 0 to 6.7A

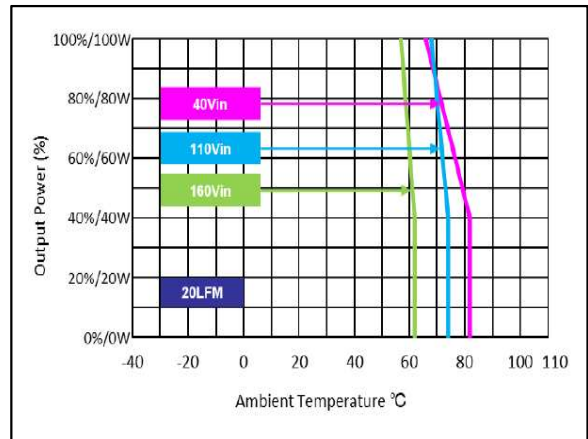

Figure 40: ERM06C100 Derating Curve with HS7 Heatsink
 Vin = 40 to 160Vdc Load: Io = 0 to 6.7A

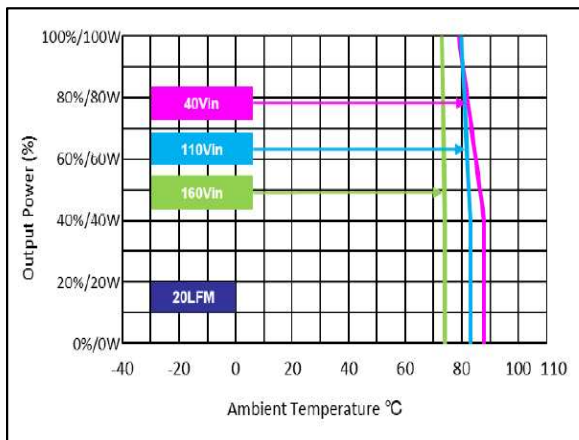

Figure 41: ERM06C100 Derating Curve with 2U iron back-plate (Dimension 241X89X1.6mm)
 Vin = 40 to 160Vdc Load: Io = 0 to 6.7A

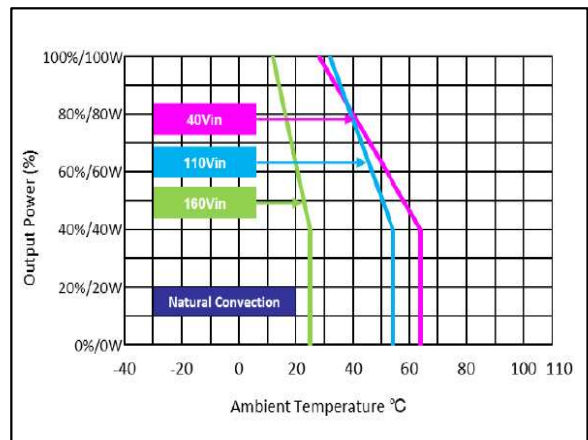

Figure 42: ERM06C100 Derating Curve with HS5 Heatsink
 Vin = 40 to 160Vdc Load: Io = 0 to 6.7A

ELECTRICAL SPECIFICATIONS

ERM06C100 Performance Curves

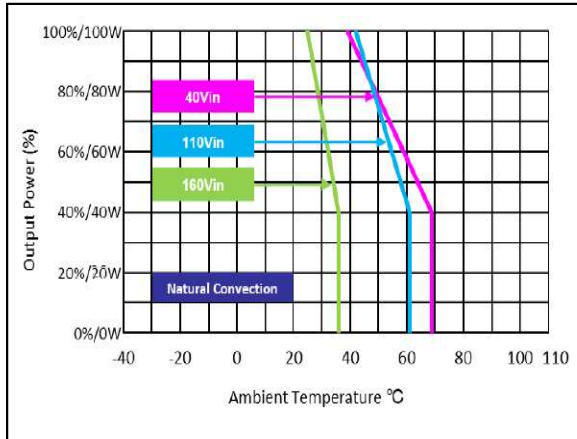

Figure 43: ERM06C100 Derating Curve with HS6 Heatsink
 Vin = 40 to 160Vdc Load: Io = 0 to 6.7A

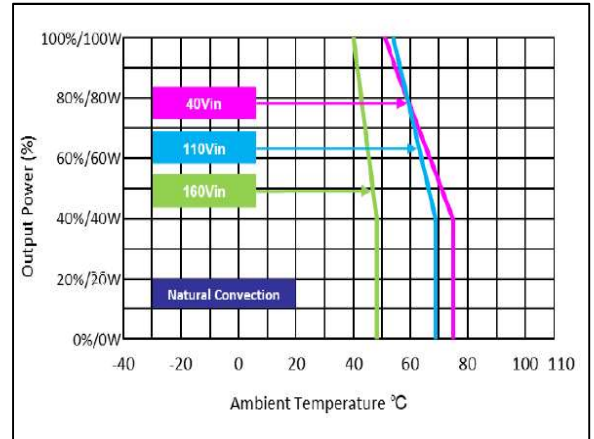

Figure 44: ERM06C100 Derating Curve with HS7 Heatsink
 Vin = 40 to 160Vdc Load: Io = 0 to 6.7A

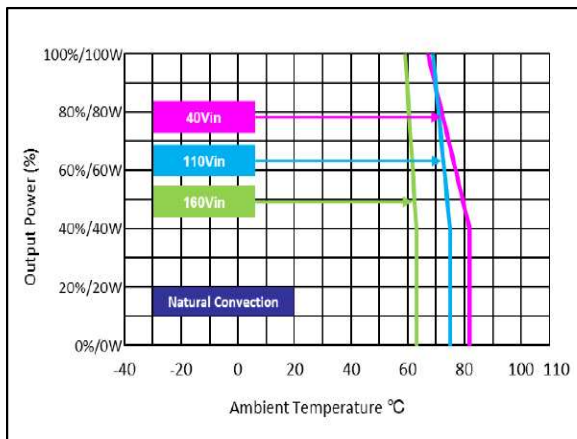

Figure 45: ERM06C100 Derating Curve with 2U iron back-plate
 (Dimension 241X89X1.6mm)
 Vin = 40 to 160Vdc Load: Io = 0 to 6.7A

ELECTRICAL SPECIFICATIONS

ERM04H100 Performance Curves

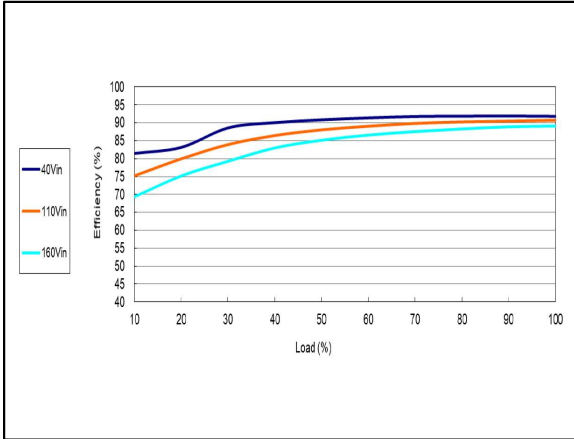

Figure 46: ERM04H100 Efficiency Versus Output Current Curve
 Vin = 110Vdc Load: Io = 0 to 4.2A

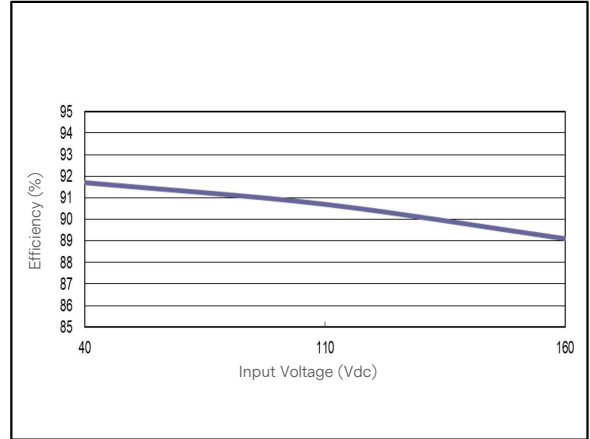

Figure 47: ERM04H100 Efficiency Versus Input Voltage Curve
 Vin = 40 to 160Vdc Load: Io = 4.2A

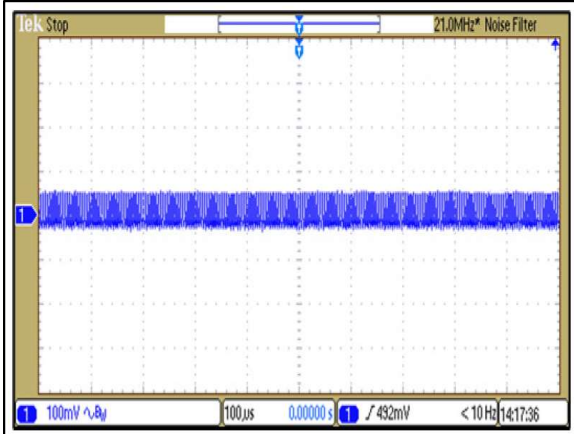

Figure 48: ERM04H100 Typical Output Ripple and Noise.
 Vin = 110Vdc Load: Io = 4.2A
 Ch 1: Vo

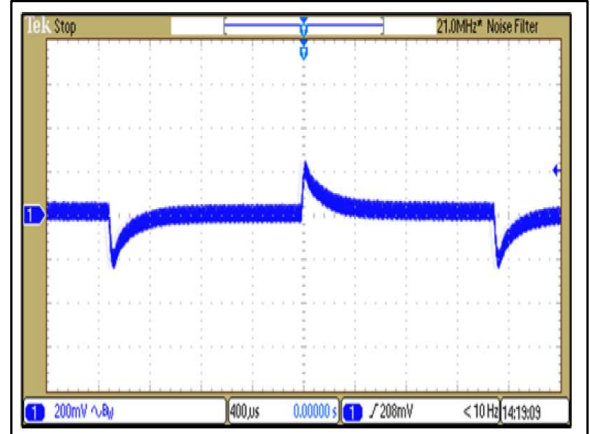

Figure 49: ERM04H100 Transient Response
 Vin = 110Vdc Load: Io = 100% to 75% load change
 Ch 1: Vo

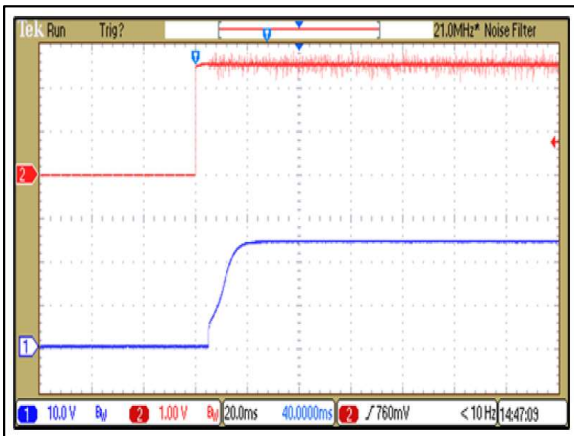

Figure 50: ERM04H100 Output Voltage Startup Characteristic by On/Off
 Vin = 110Vdc Load: Io = 4.2A
 Ch 1: Remote On/Off Ch 2: Vo

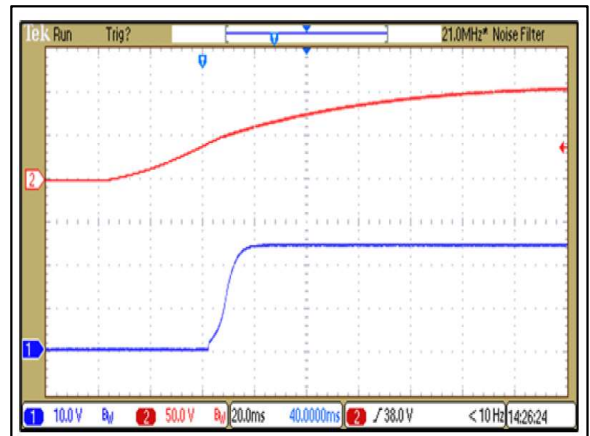

Figure 51: ERM04H100 Output Voltage Startup Characteristic by Vin
 Vin = 110Vdc Load: Io = 4.2A
 Ch 1: Vin Ch 2: Vo

ELECTRICAL SPECIFICATIONS

ERM04H100 Performance Curves

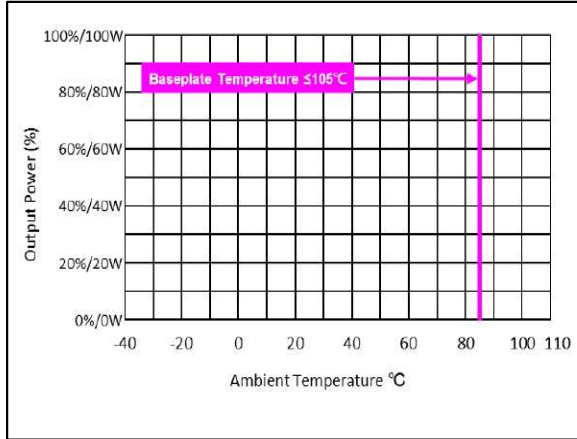

Figure 52: ERM04H100 Derating Curve without Heatsink
 Vin = 110Vdc Load: Io = 0 to 4.2A

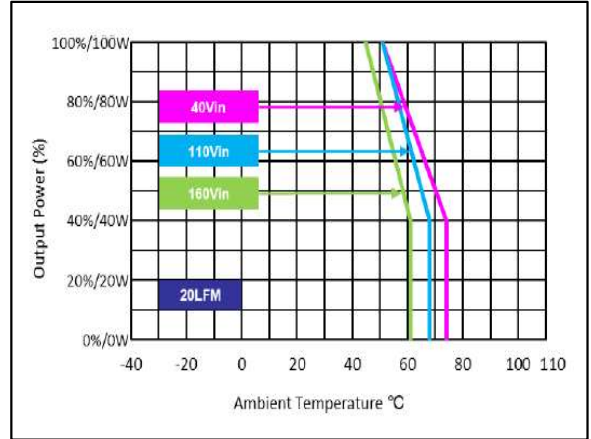

Figure 53: ERM04H100 Derating Curve with HS5 Heatsink
 Vin = 40 to 160Vdc Load: Io = 0 to 4.2A

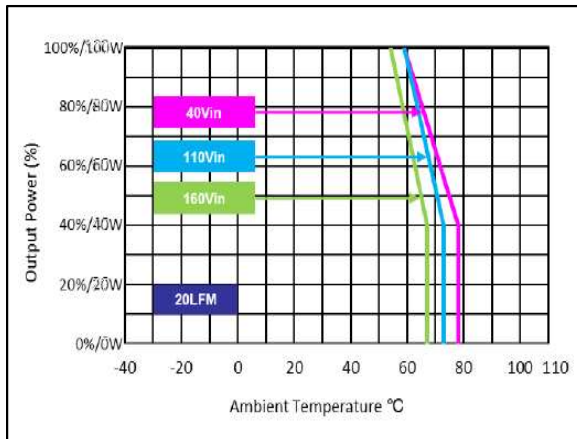

Figure 54: ERM04H100 Derating Curve with HS6 Heatsink
 Vin = 40 to 160Vdc Load: Io = 0 to 4.2A

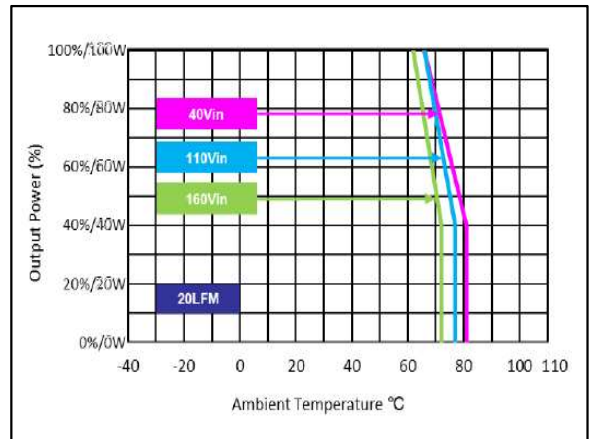

Figure 55: ERM04H100 Derating Curve with HS7 Heatsink
 Vin = 40 to 160Vdc Load: Io = 100% to 75% load change Ch 1: Vo

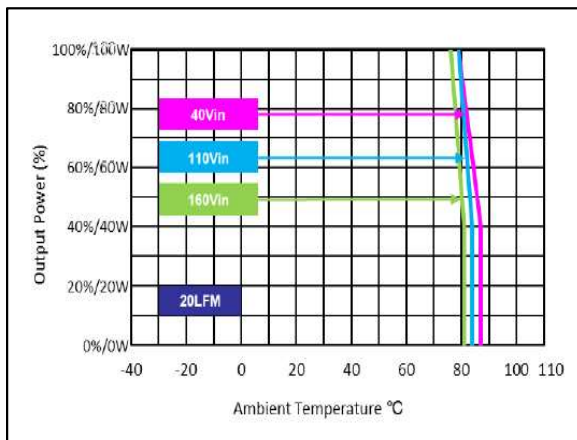

Figure 56: ERM04H100 Derating Curve with 2U iron back-plate (Dimension 241X89X1.6mm)
 Vin = 40 to 160Vdc Load: Io = 0 to 4.2A

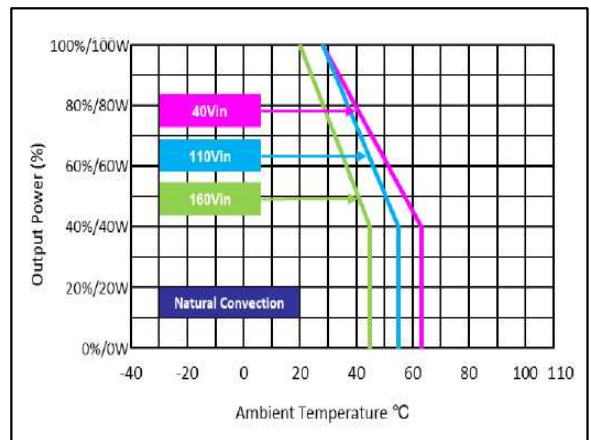

Figure 57: ERM04H100 Derating Curve with HS5 Heatsink
 Vin = 40 to 160Vdc Load: Io = 0 to 4.2A

ELECTRICAL SPECIFICATIONS

ERM04H100 Performance Curves

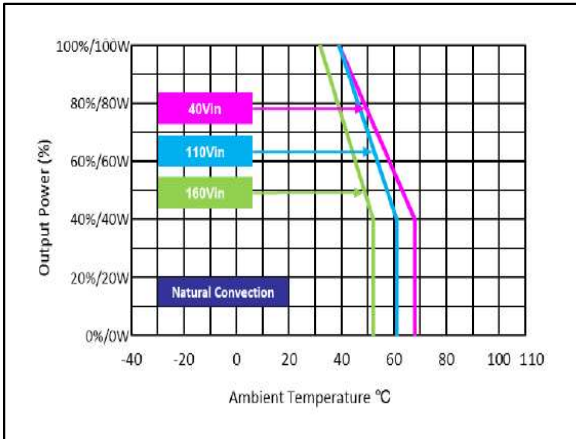

Figure 58: ERM04H100 Derating Curve with HS6 Heatsink
 Vin = 40 to 160Vdc Load: Io = 0 to 4.2A

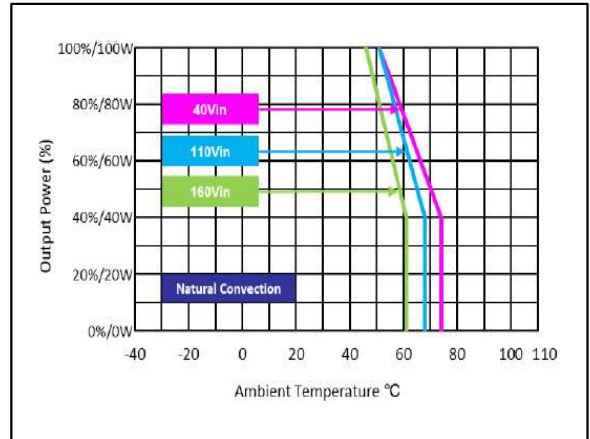

Figure 59: ERM04H100 Derating Curve with HS7 Heatsink
 Vin = 40 to 160Vdc Load: Io = 0 to 4.2A

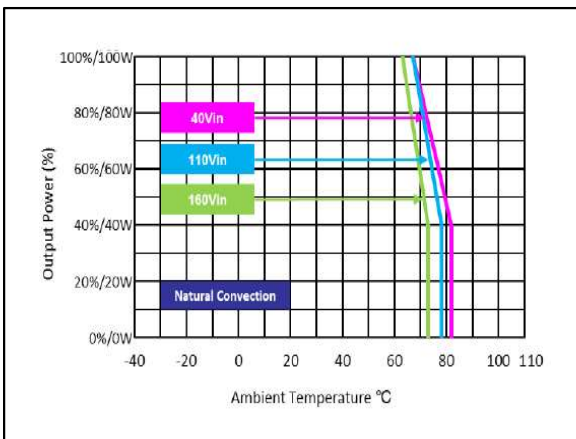

Figure 60: ERM04H100 Derating Curve with 2U iron back-plate
 (Dimension 241X89X1.6mm)
 Vin = 40 to 160Vdc Load: Io = 0 to 4.2A

ELECTRICAL SPECIFICATIONS

ERM01U100 Performance Curves

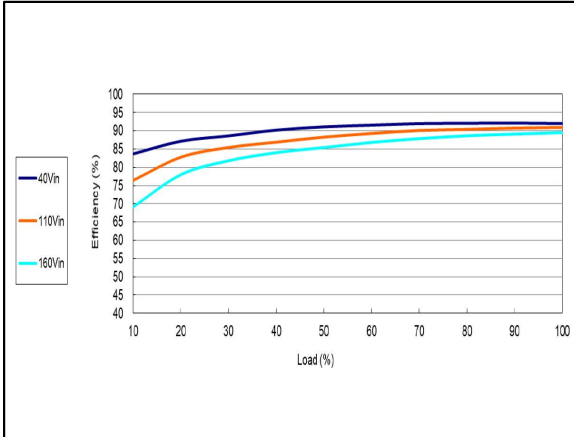

Figure 61: ERM01U100 Efficiency Versus Output Current Curve
 Vin = 110Vdc Load: Io = 0 to 1.85A

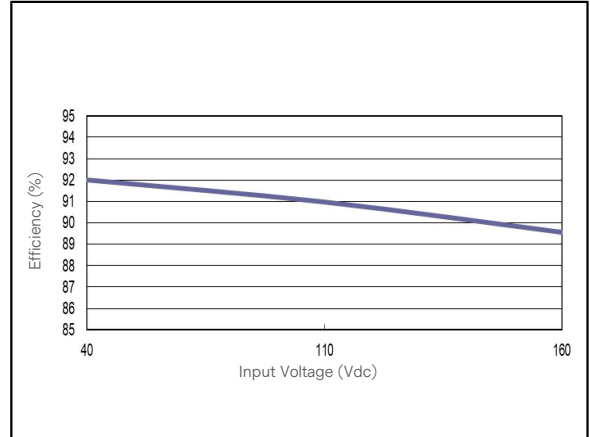

Figure 62: ERM01U100 Efficiency Versus Input Voltage Curve
 Vin = 40 to 160Vdc Load: Io = 1.85A

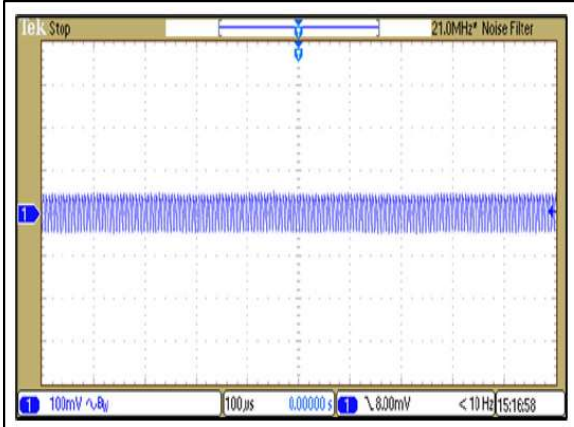

Figure 63: ERM01U100 Typical Output Ripple and Noise.
 Vin = 110Vdc Load: Io = 1.85A
 Ch 1: Vo



Figure 64: ERM01U100 Transient Response
 Vin = 110Vdc Load: Io = 100% to 75% load change
 Ch 1: Vo



Figure 65: ERM01U100 Output Voltage Startup Characteristic by On/Off
 Vin = 110Vdc Load: Io = 1.85A
 Ch 1: Remote On/Off Ch 2: Vo

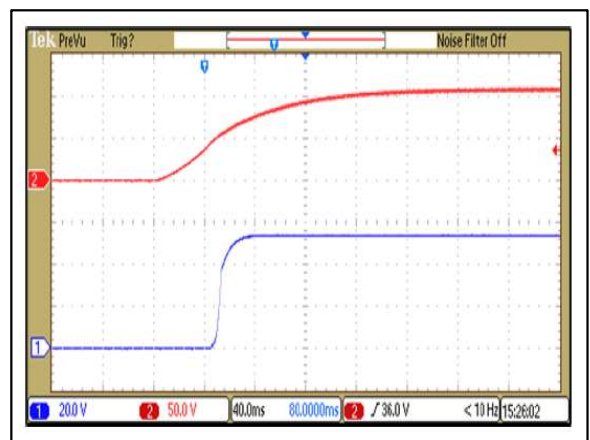

Figure 66: ERM01U100 Output Voltage Startup Characteristic by Vin
 Vin = 110Vdc Load: Io = 1.85A
 Ch 1: Vin Ch 2: Vo

ELECTRICAL SPECIFICATIONS

ERM01U100 Performance Curves

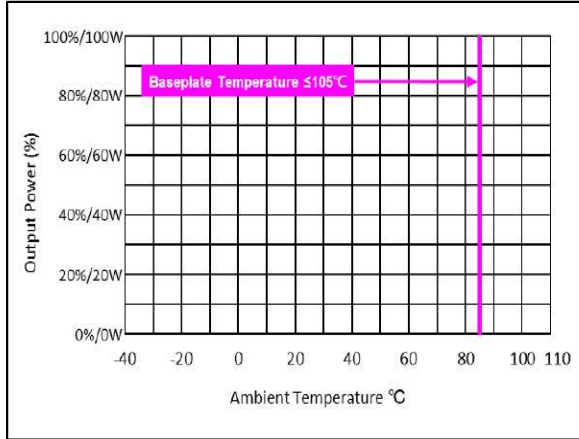

Figure 67: ERM01U100 Derating Curve without Heatsink
 Vin = 110Vdc Load: Io = 0 to 1.85A

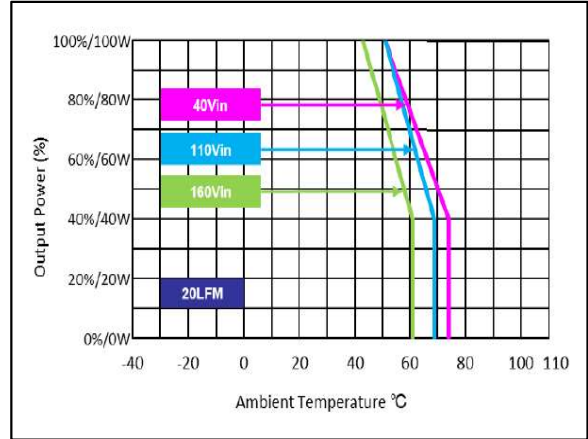

Figure 68: ERM01U100 Derating Curve with HS5 Heatsink
 Vin = 40 to 160Vdc Load: Io = 0 to 1.85A

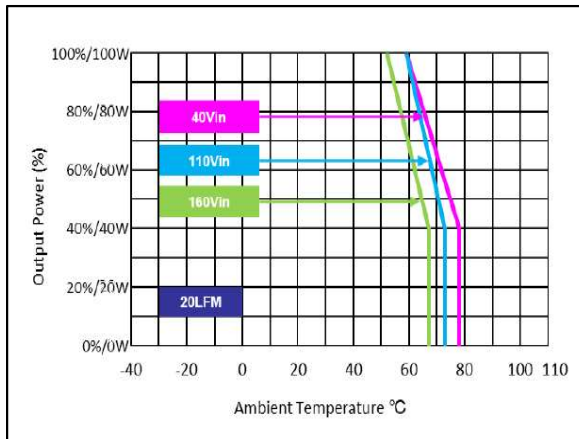

Figure 69: ERM01U100 Derating Curve with HS6 Heatsink
 Vin = 40 to 160Vdc Load: Io = 0 to 1.85A

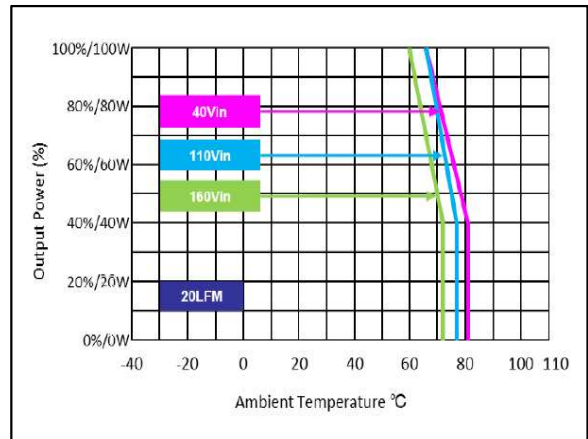

Figure 70: ERM01U100 Derating Curve with HS7 Heatsink
 Vin = 40 to 160Vdc Load: Io = 100% to 75% load change Ch 1: Vo

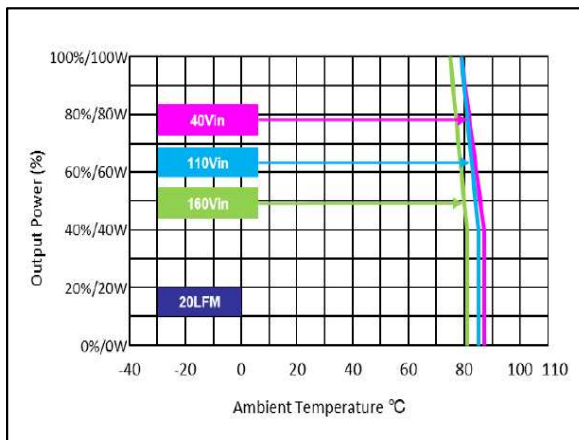

Figure 71: ERM01U100 Derating Curve with 2U iron back-plate (Dimension 241X89X1.6mm)
 Vin = 40 to 160Vdc Load: Io = 0 to 1.85A

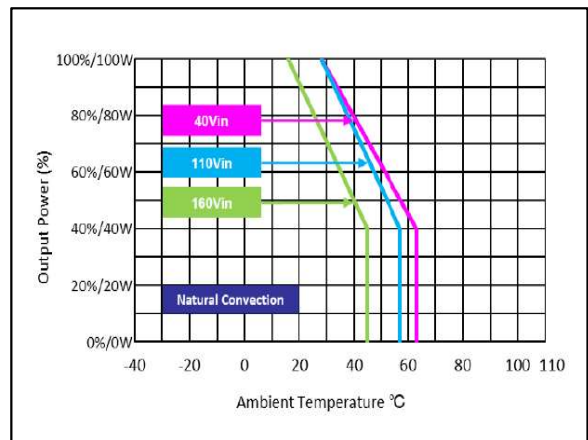

Figure 72: ERM01U100 Derating Curve with HS5 Heatsink
 Vin = 40 to 160Vdc Load: Io = 0 to 1.85A

ELECTRICAL SPECIFICATIONS

ERM01U100 Performance Curves

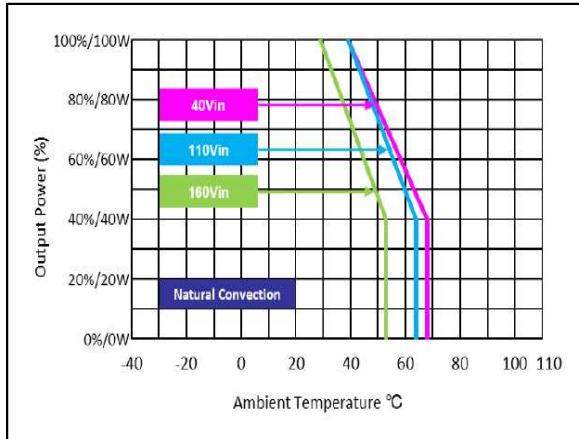

Figure 73: ERM01U100 Derating Curve with HS6 Heatsink
 Vin = 40 to 160Vdc Load: Io = 0 to 1.85A

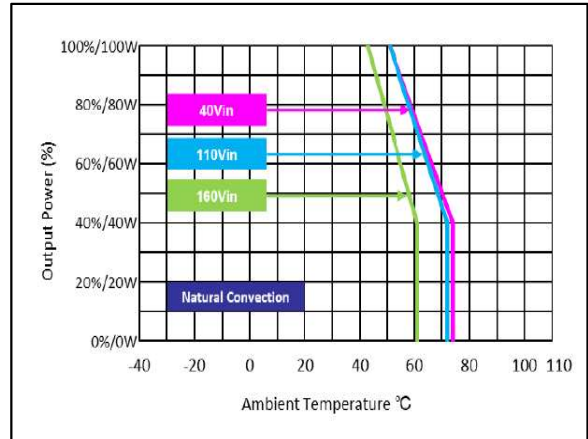

Figure 74: ERM01U100 Derating Curve with HS7 Heatsink
 Vin = 40 to 160Vdc Load: Io = 0 to 1.85A

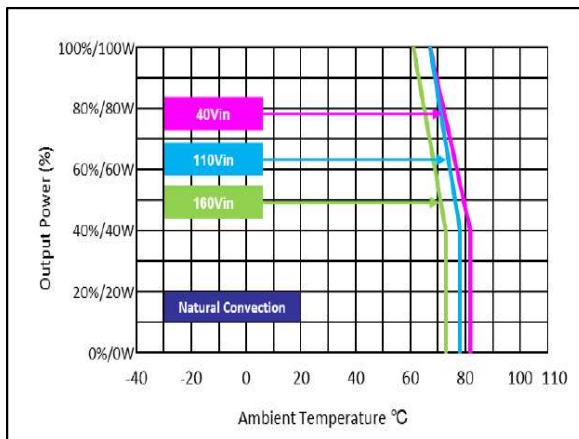
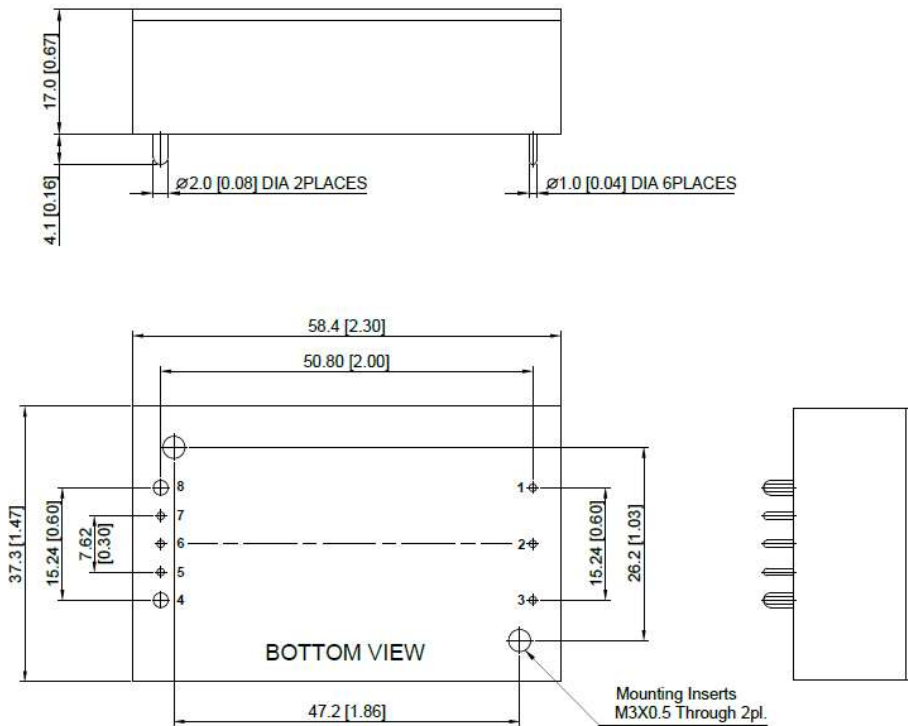

Figure 75: ERM01U100 Derating Curve with 2U iron back-plate
 (Dimension 241X89X1.6mm)
 Vin = 40 to 160Vdc Load: Io = 1.85A

MECHANICAL SPECIFICATIONS

Mechanical Outlines



Pin Connections

Pin 1	-	+Vin
Pin 2	-	Remote On/Off
Pin 3	-	-Vin
Pin 4	-	-Vout
Pin 5	-	-Sense
Pin 6	-	Trim
Pin 7	-	+Sense
Pin 8	-	+Vout

Note:

- If remote sense not used, the +sense should be connected to +output and -sense should be connected to -output.
- All dimensions in mm (inches)
Tolerance: $X.X \pm 0.5$ ($X.XX \pm 0.02$)
 $X.XX \pm 0.25$ ($X.XXX \pm 0.01$)
- Pin diameter: 1.0 ± 0.05 (0.04 ± 0.002)
- Pin diameter: 1.5 ± 0.05 (0.06 ± 0.002)

Physical Characteristics

Case Size	58.4x37.3x17.0 mm (2.30x1.47x0.67 inches)
Case Material	Plastic resin (flammability to UL 94V-0 rated)
Top Side Base Material	Aluminum Plate
Potting Material	Silicone (UL94-V0)
Weight	107g

MECHANICAL SPECIFICATIONS

Mechanical Outlines – Heatsink

ERM 150W Series

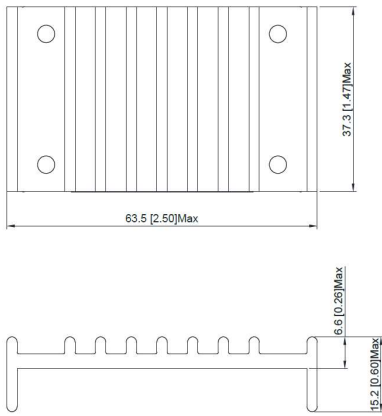

HS5

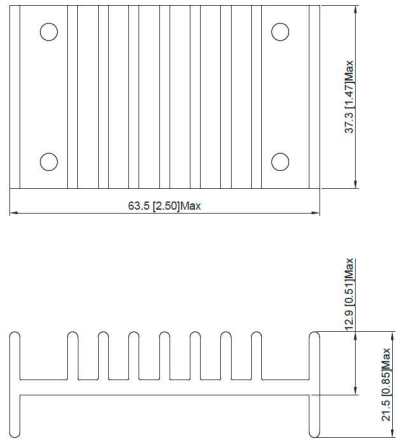

HS6

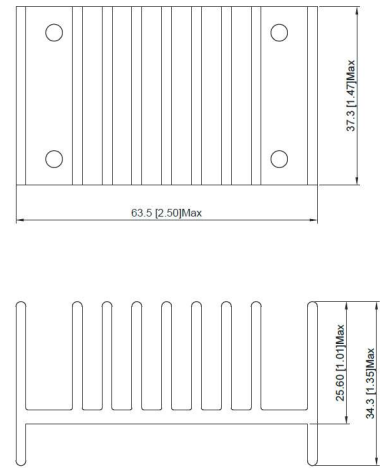

HS7

- Note:
1. All dimensions in mm (inches)
 2. Tolerance: X.X ± 0.75 (X.XX ± 0.03)
X.XX ± 0.25 (X.XXX ± 0.01)
 3. Pin diameter 1.0 ± 0.05 (0.04 ± 0.002)

Physical Characteristics

Heatsink Size	HS5: 63.5x37.8x6.6 mm (2.5x1.49x0.26 inches) HS6: 63.5x37.8x12.9 mm (2.5x1.49x0.51 inches) HS7: 63.5x37.8x25.6 mm (2.5x1.49x1.01 inches)
Material	HS5: Aluminum HS6: Aluminum HS7: Aluminum
Finish	HS5: Black Anodized Coating HS6: Black Anodized Coating HS7: Black Anodized Coating
Weight	HS5: 27g HS6: 38g HS7: 63g

ENVIRONMENTAL SPECIFICATIONS

EMC Immunity

ERM 100W Series power supply is designed to meet the following EMC immunity specifications:

Table 4. EMC Specifications:			
Parameter	Standards & Level		Performance
General	Compliance with EN50121-3-2 Railway Applications		
EMI	Conduction	EN 55032/11 with an external filter ¹	Class A
	Radiation		
EMS	EN 55024, EN 55035		
	ESD	EN61000-4-2 Air ± 8 kV, Contact ± 6 kV	Criteria A
	Radiated immunity	EN61000-4-3 10V/m	Criteria A
	Fast transient ²	EN61000-4-4 ± 2 KV	Criteria A
	Surge ²	EN61000-4-5 ± 1 KV	Criteria A
	Conducted immunity	EN61000-4-6 10Vrms	Criteria A
	PFMF	EN61000-4-8 3A/M	Criteria A

Note1 - Refer to page 30 to 33.

Note2 - To meet EN61000-4-4 & EN61000-4-5 with an external filter requested.

ENVIRONMENTAL SPECIFICATIONS

Safety Certifications

The ERM100 power supply is intended for inclusion in other equipment and the installer must ensure that it is in compliance with all the requirements of the end application. This product is only for inclusion by professional installers within other equipment and must not be operated as a stand alone product.

Table 5. Safety Certifications for ERM100 series power supply system		
Standard	Agency	Description
UL 62368-1	UL+CUL	US and Canada Requirements
EN 62368-1	TUV	European Requirements
IEC 62368-1	CB	International Electrotechnical Commission
EN 50155	TUV	Railway standard
IEC 60571	CB	Railway standard
CE Mark		European Requirements
UKCA Mark		UK Requirements

POWER AND CONTROL SIGNAL DESCRIPTIONS

Power and Signal Pins

These pins provide power and signal interface to the ERM100 series module.

Pin 1	- Vin (+)	- Input Voltage Positive
Pin 2	- Remote On/Off	- ON / OFF Control
Pin 3	- Vin (-)	- Input Voltage Return
Pin 4	- Vout (-)	- Output Voltage Return
Pin 5	- Sense (-)	- Remote Sense Return
Pin 6	- TRIM	- Output Voltage Trim
Pin 7	- Sense (+)	- Remote Sense Positive
Pin 8	- Vout (+)	- Output Voltage Positive

Vin (+), Vin (-) - (Pins 1, 3)

These pins are the input voltage positive and input voltage return pins of the module.

Remote On/Off - (Pin 2)

Remote On/Off pin allows the user to turn ON and OFF the output of the ERM100 series modules.

Parameter	Conditions	Min.	Typ.	Max.	Unit
Converter On	3.5V to 12V or Open Circuit				
Converter Off	0V to 1.2V or Short Circuit				
Control Input Current (on)	Vctrl = 5.0V	-	-	0.5	mA
Control Input Current (off)	Vctrl = 0V	-	-	-0.5	mA
Control Common	Referenced to Negative Input				
Standby Input Current	Nominal Vin	-	3	-	mA

Vout (+), Vout (-) - (Pins 8, 4)

These pins are the output voltage positive and output voltage return pins of the module.

Sense (+), Sense (-) - (Pins 7, 5)

The ERM100 is equipped with a remote sensing capability that will compensate for voltage drop between the output pins of the module and the sensed voltage point (load). This feature is implemented by connecting the Sense (+) (pin 7) and the Sense (-) (pin 5) to the positive and return rails of the output, respectively, at a location that is near to the load. Care should be taken in the routing of the sense lines as any noise sources or additional filtering components introduced into the output voltage rail may affect the stability of the power supply. The ERM100 series will operate appropriately without the sense lines connected; however it is recommended that the sense lines be connected directly to the output pins if remote sensing is not required.

POWER AND CONTROL SIGNAL DESCRIPTIONS

TRIM - (Pin 6)

Output can be externally trimmed by using the method shown below. The trim up/down range is $\pm 10\%$ minimum of the nominal output voltage.

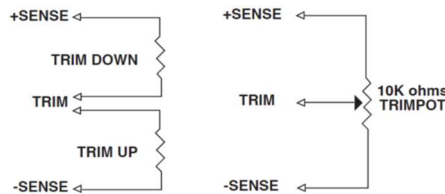

ERM20A100(N)-(HS) Trim Table:

Trim down	1	2	3	4	5	6	7	8	9	10	%
Vout=	Vox0.99	Vox0.98	Vox0.97	Vox0.96	Vox0.95	Vox0.94	Vox0.93	Vox0.92	Vox0.91	Vox0.90	Vdc
Rd=	138.88	62.41	36.92	24.18	16.53	11.44	7.79	5.06	2.94	1.24	KOhm
Trim up	1	2	3	4	5	6	7	8	9	10	%
Vout=	Vox1.01	Vox1.02	Vox1.03	Vox1.04	Vox1.05	Vox1.06	Vox1.07	Vox1.08	Vox1.09	Vox1.10	Vdc
Ru=	106.87	47.76	28.06	18.21	12.30	8.36	5.55	3.44	1.79	0.48	KOhm

ERM08B100(N)-(HS) Trim Table:

Trim down	1	2	3	4	5	6	7	8	9	10	%
Vout=	Vox0.99	Vox0.98	Vox0.97	Vox0.96	Vox0.95	Vox0.94	Vox0.93	Vox0.92	Vox0.91	Vox0.90	Vdc
Rd=	413.55	184.55	108.22	70.05	47.15	31.88	20.98	12.80	6.44	1.35	KOhm
Trim up	1	2	3	4	5	6	7	8	9	10	%
Vout=	Vox1.01	Vox1.02	Vox1.03	Vox1.04	Vox1.05	Vox1.06	Vox1.07	Vox1.08	Vox1.09	Vox1.10	Vdc
Ru=	351.00	157.50	93.00	60.75	41.40	28.50	19.29	12.37	7.00	2.70	KOhm

ERM06C100(N)-(HS) Trim Table:

Trim down	1	2	3	4	5	6	7	8	9	10	%
Vout=	Vox0.99	Vox0.98	Vox0.97	Vox0.96	Vox0.95	Vox0.94	Vox0.93	Vox0.92	Vox0.91	Vox0.90	Vdc
Rd=	530.73	238.61	141.24	92.56	63.35	43.87	29.96	19.53	11.41	4.92	KOhm
Trim up	1	2	3	4	5	6	7	8	9	10	%
Vout=	Vox1.01	Vox1.02	Vox1.03	Vox1.04	Vox1.05	Vox1.06	Vox1.07	Vox1.08	Vox1.09	Vox1.10	Vdc
Ru=	422.77	189.89	112.26	73.44	50.15	34.63	23.54	15.22	8.75	3.58	KOhm

POWER AND CONTROL SIGNAL DESCRIPTIONS

ERM04H100(N)-(HS) Trim Table:

Trim down	1	2	3	4	5	6	7	8	9	10	%
Vout=	Vox0.99	Vox0.98	Vox0.97	Vox0.96	Vox0.95	Vox0.94	Vox0.93	Vox0.92	Vox0.91	Vox0.90	Vdc
Rd=	598.66	267.78	157.49	102.34	69.25	47.19	31.44	19.62	10.43	3.08	KOhm
Trim up	1	2	3	4	5	6	7	8	9	10	%
Vout=	Vox1.01	Vox1.02	Vox1.03	Vox1.04	Vox1.05	Vox1.06	Vox1.07	Vox1.08	Vox1.09	Vox1.10	Vdc
Ru=	487.14	218.02	128.31	83.46	56.55	38.61	25.79	16.18	8.70	2.72	KOhm

ERM01U100(N)-(HS) Trim Table:

Trim down	1	2	3	4	5	6	7	8	9	10	%
Vout=	Vox0.99	Vox0.98	Vox0.97	Vox0.96	Vox0.95	Vox0.94	Vox0.93	Vox0.92	Vox0.91	Vox0.90	Vdc
Rd=	1882.57	877.94	543.06	375.62	275.15	208.18	160.34	124.46	96.55	74.23	KOhm
Trim down	11	12	13	14	15						%
Vout=	Vox0.89	Vox0.88	Vox0.87	Vox0.86	Vox0.85						Vdc
Ru=	55.96	40.74	27.86	16.82	7.25						KOhm
Trim up	1	2	3	4	5						%
Vout=	Vox1.01	Vox1.02	Vox1.03	Vox1.04	Vox1.05						Vdc
Ru=	560.73	230.36	120.24	65.18	32.15						KOhm

APPLICATION NOTES

Output Ripple Reduction

A good quality low ESR capacitor placed as close as practicable across the load will give the best ripple and noise performance. To reduce output ripple, it is recommended to use 4.7 μ F capacitors at the output.

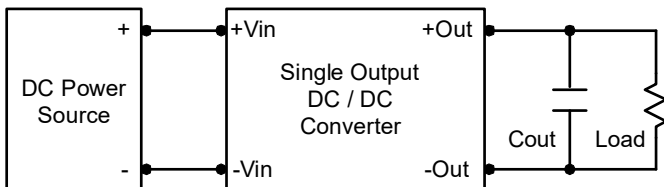

Peak-to-Peak Output Noise Measurement Test

Use a 22 μ F polymer capacitor for 5V, 12V, 15V output models and a 33 μ F polymer capacitor for 24V output model and a 1 μ F ceramic capacitor for 54V output model. Scope measurement should be made by using a BNC socket, measurement bandwidth is 0-20MHz. Position the load between 50 mm and 75 mm from the DC/DC Converter.

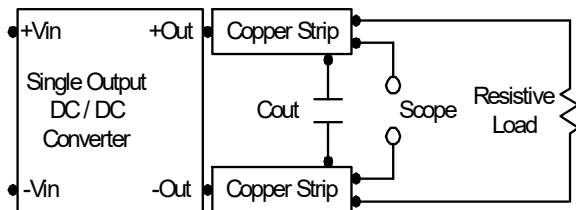

Maximum Capacitive Load

The ERM100 series has limitation of maximum connected capacitance at the output. The power module may be operated in current limiting mode during start-up, affecting the ramp-up and the startup time. The maximum capacitance can be found in table 3.

APPLICATION NOTES

Thermal Considerations

Many conditions affect the thermal performance of the power module, such as orientation, airflow over the module and board spacing. To avoid exceeding the maximum temperature rating of the components inside the power module, the case temperature must be kept below 105 °C. The derating curves are determined from measurements obtained in a test setup.

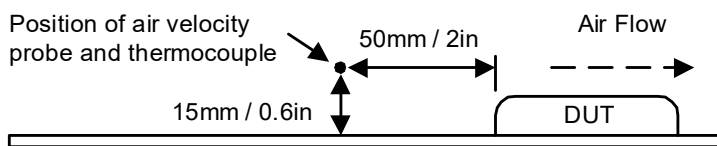

Output Voltage and Efficiency Measurement Test

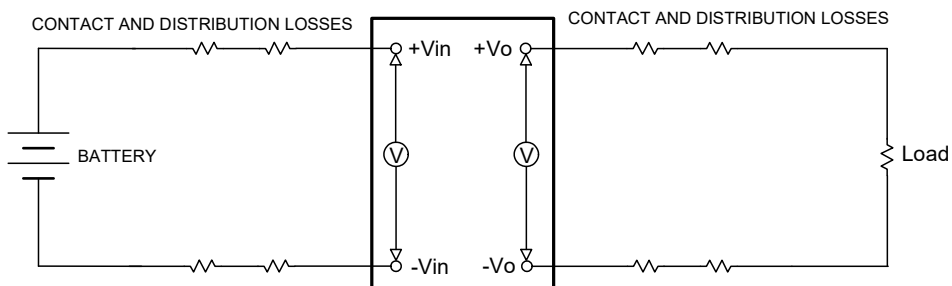

$$\text{Efficiency} = \left(\frac{V_{out} \times I_{out}}{V_{in} \times I_{in}} \right) \times 100\%$$

APPLICATION NOTES

EMI Emissions

Recommended circuit to comply EN55032 Class A Limits

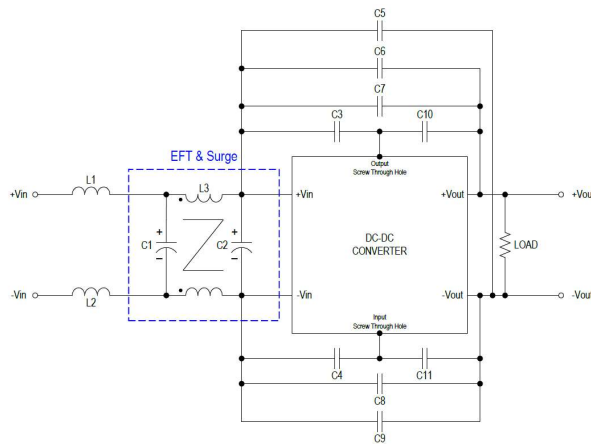

Recommended PCB Layout with Input Filter

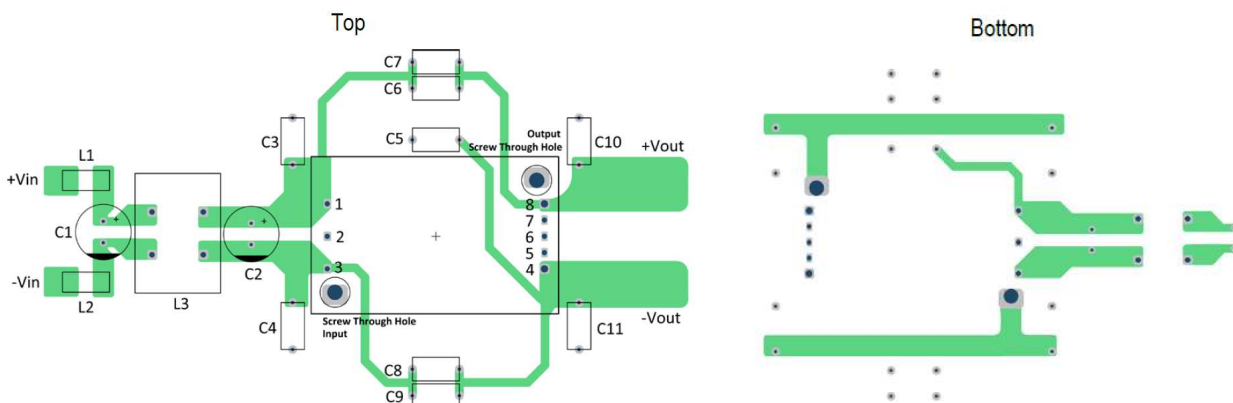

To: comply with EN55032 Class A following components are needed:

Model	Component	Value
ERM20A100	L1,L2	425Ω(25MHz)/5A
	C1	150uF/200V
	L3	7mH/7A
	C2	82uF/200V
	C3, C4, C10, C11	220pF/Y1 Cap
	C5, C7, C8	2200pF/Y1 Cap
	C6, C9	4700pF/Y1 Cap

APPLICATION NOTES

Model	Component	Value
ERM01U100	L1,L2	425Ω(25MHz)/5A
	C1, C2	150uF/200V
	L3	9mH/7A
	C3, C4, C10, C11	470pF/Y1 Cap
	C5	2200pF/Y1 Cap
	C6, C9	-
	C7, C8	4700pF/Y1 Cap

Recommended circuit to comply EN55032 Class A Limits

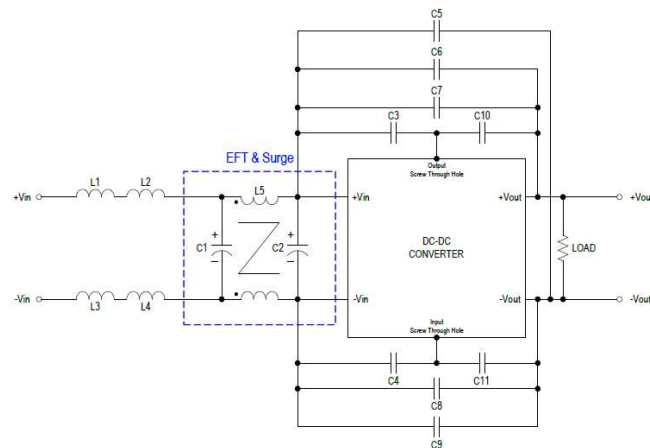

Recommended PCB Layout with Input Filter

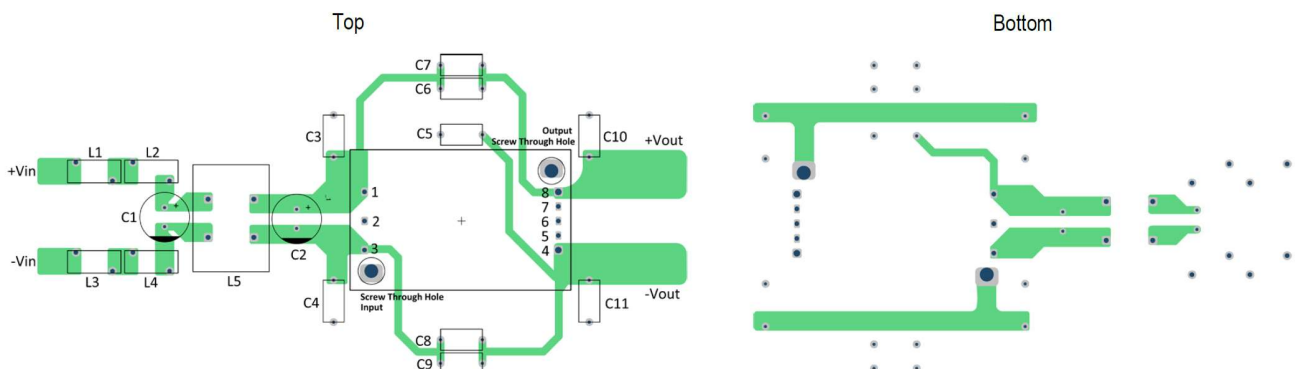

APPLICATION NOTES

To: comply with EN55032 Class A following components are needed:

Model	Component	Value
ERM08B100 ERM06C100	L1, L2, L3, L4	2uH/5A
	C1, C2	150uF/200V
	L5	9mH/5A
	C3, C4, C10, C11	470pF/Y1 Cap
	C5	2200pF/Y1 Cap
	C6, C9	-
	C7, C8	4700pF/Y1 Cap

Model	Component	Value
ERM04H100	L1, L2, L3, L4	2uH/5A
	C1, C2	150uF/200V
	L5	3.3mH/4A
	C2	82uF/200V
	C3, C4, C10, C11	2200pF/Y1 Cap
	C5	2200pF/Y1 Cap
	C6, C9	-
	C7, C8	1000pF/Y1 Cap

APPLICATION NOTES

Recommended circuit to comply EN55032 Class B Limits

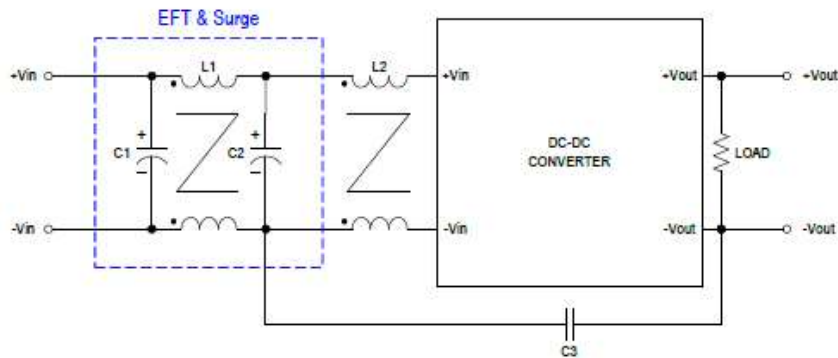

Recommended PCB Layout with Input Filter

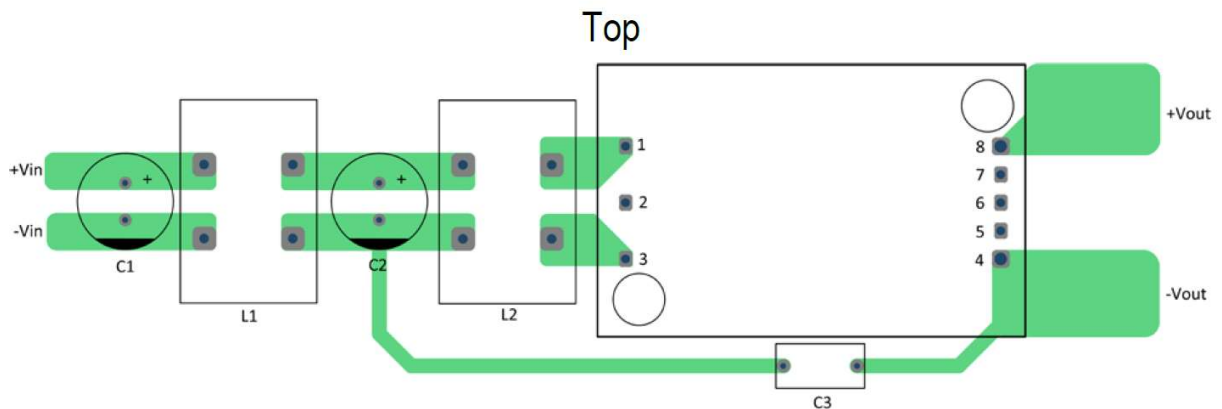

To comply with EN55032 Class B following components are needed:

Model	Component	Value
ERM100 Series	C1	390uF/200V
	C2	150uF/200V
	C3	4700pF/Y1 Cap
	L1	7mH/7A
	L2	2.2mH/6A

APPLICATION NOTES

Remote ON/OFF Control

Positive logic remote on/off turns the module on during a logic high voltage on the remote on/off pin, and off during a logic low. To turn the power module on and off, the user must supply a switch to control the voltage between the on/off terminal and the -Vin terminal. The switch can be an open collector or equivalent. A logic low is 0V to 1.2V. A logic high is 3.5V to 12V. The maximum sink current at the on/off terminal (Pin 3) during a logic low is -100uA. The ON/OFF input signal (Von/off) that referenced to GND. If not using the remote on/off feature, please open circuit between on/off pin and -Vin pin to turn the module on. Remote ON/OFF implementation is below.

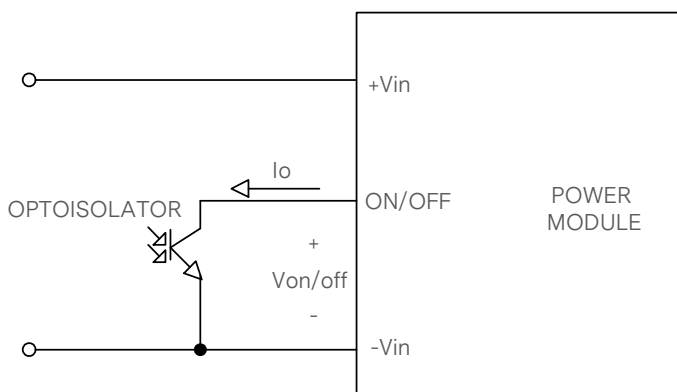

Isolate-Closure Remote ON/OFF

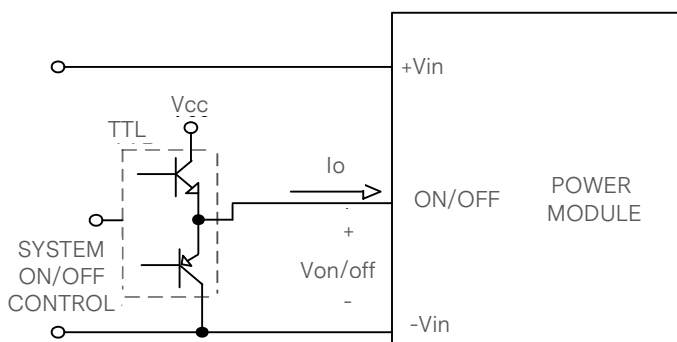

Level Control Using TTL Output

APPLICATION NOTES

Packaging Information

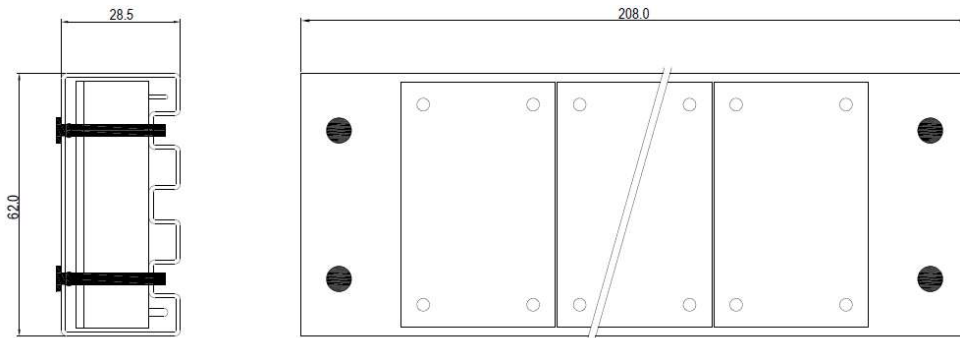

Unit: mm
5 PCS per TUBE (Without heatsink)

Soldering and Reflow Considerations

Lead free wave solder profile for ERM100 Series

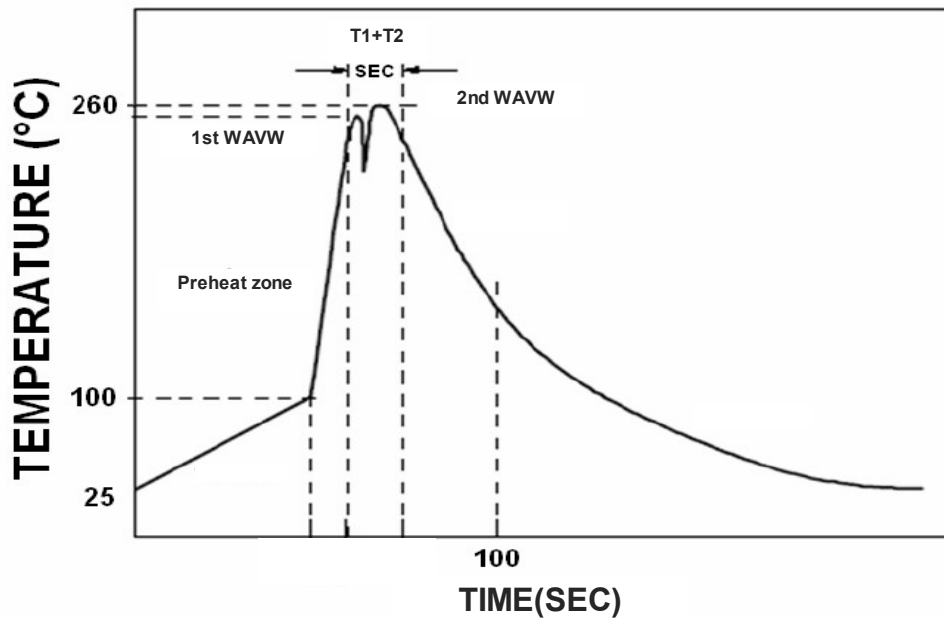

RECORD OF REVISION AND CHANGES

Issue	Date	Description	Originators
1.0	08.08.2022	First Issue	J.Zhang



For international contact information,
visit advancedenergy.com.

powersales@aei.com (Sales Support)
productsupport.ep@aei.com (Technical Support)
+1 888 412 7832

ABOUT ADVANCED ENERGY

Advanced Energy (AE) has devoted more than three decades to perfecting power for its global customers. AE designs and manufactures highly engineered, precision power conversion, measurement and control solutions for mission-critical applications and processes.

Our products enable customer innovation in complex applications for a wide range of industries including semiconductor equipment, industrial, manufacturing, telecommunications, data center computing, and medical. With deep applications know-how and responsive service and support across the globe, we build collaborative partnerships to meet rapid technological developments, propel growth for our customers, and innovate the future of power.

PRECISION | POWER | PERFORMANCE

Specifications are subject to change without notice. Not responsible for errors or omissions. ©2020 Advanced Energy Industries, Inc. All rights reserved. Advanced Energy®, and AE® are U.S. trademarks of Advanced Energy Industries, Inc.